

# ***NEXGEN10 and 10R***

## ***Installation, Operation, and Maintenance Manual***



# TABLE OF CONTENTS

<b>1.0 DESCRIPTION</b>	<b>3</b>
1.1 General Information	3
1.2 Principals of Operation	4
1.3 Specifications, Certifications, and Sizing Guidelines	5
<b>2.0 INSTALLATION</b>	<b>7</b>
2.1 Unpacking	7
2.2 Storage	7
2.3 Safety Considerations	7
2.4 Plan Ahead	9
2.5 Additional Parts Required for Installation	9
2.6 Power Supply Electrical Connections	10
2.7 Bonding	11
2.8 Plumbing Connections	12
2.9 Saturated Salt Feeder Installation	14
2.10 Plumbing the Overflow	15
2.11 Preparing the pH Neutral System	16
2.12 Plumbing the Hydrogen Vent	16
<b>3.0 OPERATION</b>	<b>17</b>
3.1 Start-up Procedures and Checks	17
3.2 Adjusting Chlorine Output	17
3.3 Touch-screen Icon Explanations	18
3.4 Using the Touchscreen	19
<b>4.0 MAINTENANCE</b>	<b>26</b>
4.1 Routine Maintenance	26
4.2 Cell Cleaning Procedure	26
<b>5.0 WARRANTY INFORMATION</b>	<b>41</b>

Note: This manual is subject to change at any time based on system improvements, design changes, authorized modifications, or new information. Please consult ChlorKing for the latest revision.

Manufacturer:  
ChlorKing Inc  
2935 Northeast Parkway  
Atlanta, GA 30360  
1-800-536-8180

# SECTION 1 DESCRIPTION

## 1.1 GENERAL INFORMATION

The NEXGEN system is an on-site sodium hypochlorite generator designed for commercial swimming pool applications. The NEXGEN can produce up to 12 pounds of equivalent chlorine per day. The system manufactures bleach continuously from a salt concentration of 5000ppm to 7000ppm and uses the water from the pool as a raw material. This unique feature eliminates issues with high TDS levels and requires less salt as raw material than traditional methods. The NEXGEN is designed for commercial service and can be run 24 hours a day or controlled by any pool controller. "R" models are reverse polarity which reduces maintenance. The basic components of the NEXGEN are outlined below.



## **1.2 PRINCIPALS OF OPERATION**

### ***Production Tank Assembly***

The production tank assembly consists of a polyethylene tank, an external electrolytic cell, a circulation pump, and heat exchanger. Pool water from the pool return line is fed into the production tank. The circulation pump circulates water through the electrolytic cells and heat exchanger. The water in the tank is maintained between 5000-ppm and 7000-ppm salt concentration. The electrolytic cells produce a 1666-ppm to 2500-ppm sodium hypochlorite solution. The sodium hypochlorite flows to the pool at flow rates from .16-gpm to .6-gpm. The flow rate through the tank dictates the amount of sodium hypochlorite produced. Sodium hypochlorite can be produced up to 12lbs of equivalent chlorine. The sodium hypochlorite flows to the pool for use in disinfection. The heat exchanger has fresh pool water pumped through the coils to maintain tank temperatures of no more than 10 degrees F above the pool water.

### ***Dilution Fan***

Electrochemical production of sodium hypochlorite produces hydrogen as a byproduct. The dilution fan pumps fresh air into the production tank to dilute the hydrogen and force it out the vent. The vent must be vented to outside atmosphere.

### ***Saturated Salt Feeder***

The saturated salt feeder supplies the production tank with a constant supply of salt to produce sodium hypochlorite. Salt is used at the rate of 2 pounds per pound of equivalent chlorine produced or 3 pounds per pound of equivalent chlorine produced depending on production quantity selected. The saturated salt feeder is filled manually. Salt is pumped using standard peristaltic chemical feed pumps.

### ***Chemical Metering***

Chemical metering is accomplished using a venturi. The flow through the venturi is adjusted to provide the flow rate necessary to deliver the rated production of chlorine to the pool.

### ***Power Supply and Control Box***

The power supply provides the current to the electrolytic cells to produce the rated amount of sodium hypochlorite. The power supply houses all the safety features to prevent system operation in the event of a malfunction.

## **1.3 GENERAL SPECIFICATIONS**

### ***Sodium hypochlorite production:***

NEXGEN10 - Up to 12 pounds per day at 7000ppm

NEXGEN10R - Up to 12 pounds per day at 7000ppm

### ***Maximum pool return line pressure:***

25 PSI including plumbing to and from the venturi injector

### ***Electrical requirements:***

#### **NEXGEN10 and 10R**

Rated 208/240 VAC, 22.38 A, 50/60 Hz.

Requires:

208/240 volt single phase connection @ 30 amps and 50/60 Hz

120 volt connection to a chemical feed controller or 120 volt outlet @1 amp

### ***Certifications***

NEXGEN10 and 10R are certified for indoor installation.

NSF Standard 50

UL Standard 1081

CSA Standard C22.2 #218.1

PRMA Reg. No. 33004

### ***Sizing guidelines***

Chlorinator sizing must comply with local codes. Please contact your local health department for specific requirements or contact your local ChlorKing representative for assistance.

# DIMENSIONS

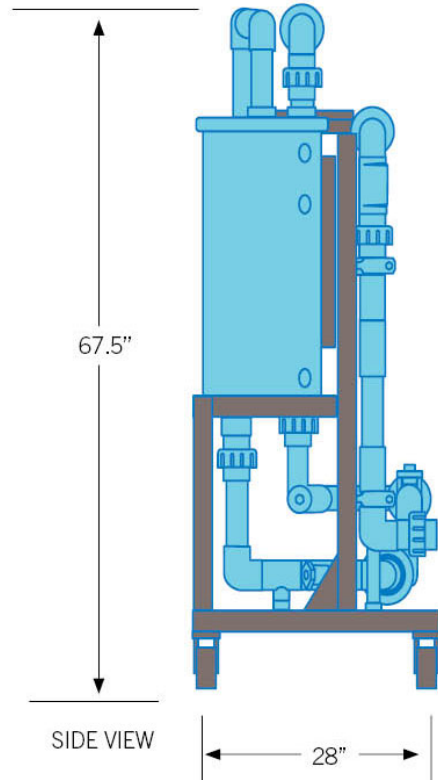
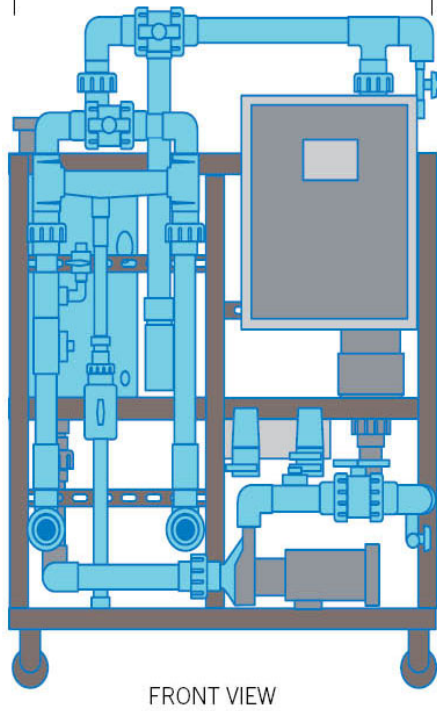
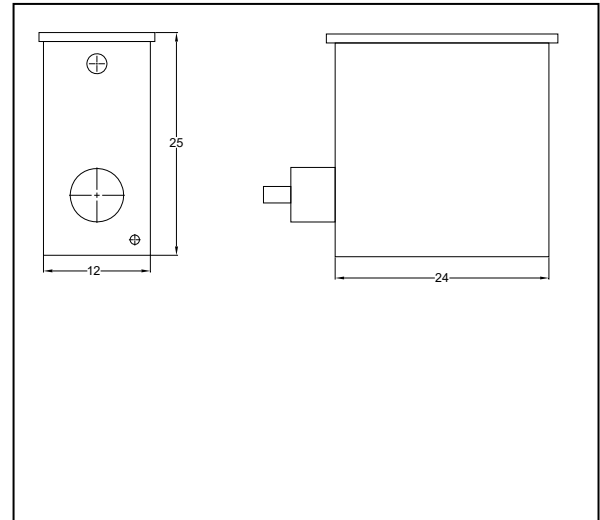
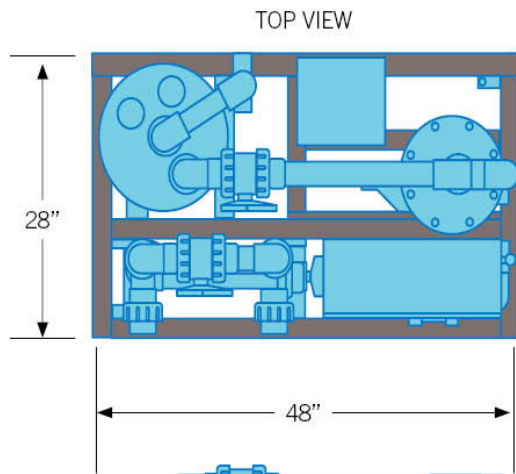

## SECTION 2 INSTALLATION

### 2.1 UNPACKING

Units are shipped from the factory. In the event of damages during shipping, it is the responsibility of the customer to notify the carrier immediately and to file a damage claim. Open the crate carefully and examine all material inside.

### 2.2 STORAGE

When storing units, use the original packaging and store under a shelter to protect the contents from weather.

### 2.3 SAFETY CONSIDERATIONS

#### IMPORTANT SAFETY INSTRUCTIONS

#### READ AND FOLLOW ALL INSTRUCTIONS

#### SAVE THESE INSTRUCTIONS

WHEN INSTALLING, OPERATING, AND MAINTAINING THIS EQUIPMENT, KEEP SAFETY CONSIDERATIONS FOREMOST. USE PROPER TOOLS, PROTECTIVE CLOTHING, AND EYE PROTECTION WHEN WORKING ON OR INSTALLING THE EQUIPMENT. FOLLOW THE INSTRUCTIONS IN THIS MANUAL AND TAKE ANY ADDITIONAL SAFETY MEASURES APPROPRIATE. BE EXTREMELY CAREFUL IN THE PRESENCE OF HAZARDOUS SUBSTANCES.

THE PERSONNEL RESPONSIBLE FOR INSTALLATION, OPERATION, AND MAINTENANCE OF THIS EQUIPMENT MUST BE FULLY FAMILIAR WITH THE CONTENTS OF THIS MANUAL.

ANY SERVICING OF THIS EQUIPMENT MUST BE DONE WITH THE UNIT FULLY OFF AND DISCONNECTED FROM THE POWER SOURCE AND ALL PRESSURE BLED FROM THE LIQUID LINES.

#### WARNING

- **CHLORKING®** SYSTEMS ARE INTENDED TO BE INSTALLED ACCORDING TO ALL LOCAL AND NATIONAL REGULATIONS.
- **CONNECT THE EQUIPMENT ASSEMBLY TO A CIRCUIT PROTECTED BY A GROUND-FAULT CIRCUIT-INTERRUPTER.**

- ONLY A CERTIFIED TECHNICIAN MAY INSTALL AND SERVICE THE **CHLORKING®** NEXGEN SYSTEM.
- MODIFYING THE **CHLORKING®** NEXGEN SYSTEM IN ANY WAY MAY CAUSE BODILY INJURY AND WILL VOID THE WARRANTY.
- DO NOT ALLOW CHILDREN OR ANYONE NOT CAPABLE TO OPERATE THE **CHLORKING®** NEXGEN SYSTEM.
- ONLY REPLACE COMPONENTS WITH THOSE SPECIFIED BY THE MANUFACTURER.
- WHEN INSTALLING THE SYSTEM, ENSURE THAT POWER IS LINKED TO THE MAIN PUMP POWER SOURCE FOR THE POOL TO ENSURE THAT THE **CHLORKING®** NEXGEN SYSTEM NEVER OPERATES WHEN THE PUMPS ARE OFF.
- ALL BOXES ON THE **CHLORKING®** NEXGEN SYSTEM CONTAIN HIGH VOLTAGE COMPONENTS. NEVER OPEN ANY BOX WHILE THE POWER IS ON.
- THE SYSTEM HAS THE POTENTIAL TO RELEASE HIGH DOSES OF CHORINE. USE CAUTION WHEN HANDLING, SERVICING, OR OPERATING THE EQUIPMENT.
- DO NOT ENERGIZE OR OPERATE THE SYSTEM IF THE CELL HOUSING IS DAMAGED OR IMPROPERLY ASSEMBLED.
- THE MOUNTING LOCATION OF THE UNIT MUST BE AT LEAST 1.5 METERS FROM THE POOL.

## **CONSERVEZ CES INSTRUCTIONS**

LORS DE L'INSTALLATION, DE FONCTIONNEMENT ET L'ENTRETIEN DE CET ÉQUIPEMENT, GARDEZ LES CONSIDÉRATIONS SUR LA SÉCURITÉ AVANT TOUT. UTILISER DES OUTILS APPROPRIÉS, DES VÊTEMENTS DE PROTECTION ET LUNETTES DE PROTECTION LORSQU'ILS TRAVAILLENT SUR OU À L'INSTALLATION. SUIVEZ LES INSTRUCTIONS DE CE MANUEL ET PREND LES MESURES DE SÉCURITÉ SUPPLÉMENTAIRES APPROPRIÉES. SOYEZ VIGILANTS EN PRÉSENCE DE SUBSTANCES DANGEREUSES.

LE PERSONNEL CHARGÉ DE L'INSTALLATION, DE FONCTIONNEMENT ET D'ENTRETIEN DE CE MATÉRIEL DOIT ÊTRE PARFAITEMENT FAMILIARISÉ AVEC LE CONTENU DE CE MANUEL.

AUCUNE OPÉRATION DE MAINTENANCE DE CET ÉQUIPEMENT DOIT ÊTRE FAITE AVEC L'UNITÉ ENTIÈREMENT ÉTEINT ET DÉBRANCHÉE DE L'ÉLECTRICITÉ ET TOUTE LA PRESSON SAIGNÉ À PARTIR DES LIGNES DE LIQUIDES.

**MISE EN GARDE**



- **CHLORKING® SYSTEMES SONT DESTINES A ETRE INSTALLES SELON TOUS LES REGLEMENTS LOCAUX ET NATIONAUX.**
- **CONNECTER LE MONTAGE DE L'ÉQUIPEMENT SUR UN CIRCUIT PROTÉGÉ PAR UN DISJONCTEUR DE FUITE À LA TERRE.**
- **SEUL UN TECHNICIEN CERTIFIÉ PEUT INSTALLER ET ENTREtenir LE SYSTEME CHLORKING® NEXGEN.**
- **MODIFIANT LA CHLORKING® NEXGEN SYSTEME EN QUELQUE SORTE PEUT CAUSER DES LESIONS CORPORELLES ET LA GARANTIE ANNULATION.**
- **N'AUTORISENT PAS LES ENFANTS OU N'IMPORTE QUI PAS CAPABLE D'ALIMENTER LE SYSTEME CHLORKING® NEXGEN.**
- **REPLACEZ UNIQUEMENT LES COMPOSANTS AVEC CELLES SPÉCIFIÉES PAR LE FABRICANT.**
- **LORSQUE VOUS INSTALLEZ LE SYSTEME, S'ASSURER QUE LA PUISSANCE EST LIEE A LA SOURCE D'ALIMENTATION DE POMPE A MAIN POUR LA PISCINE POUR VOUS ASSURER QUE LE SYSTEME DE NEX-GEN CHLORKING® FONCTIONNE JAMAIS QUAND LES POMPES SONT HORS SERVICE.**
- **TOUTES LES CASES SUR LE SYSTEME CHLORKING® NEXGEN CONTIENNENT DES COMPOSANTS HAUTE TENSION. NE JAMAIS OUVRIR N'IMPORTE QUELLE BOÎTE TANDIS QUE L'APPAREIL EST ALLUMÉ.**
- **LE SYSTÈME A LA POSSIBILITÉ DE LIBÉRER DES DOSES ÉLEVÉES DE CHLORE. SOYEZ PRUDENT LORS DE MANIPULATION, ENTRETIEN OU FONCTIONNEMENT DE L'ÉQUIPEMENT.**
- **NE PAS METTRE SOUS TENSION OU FAIRE FONCTIONNER LE SYSTÈME SI LE BOÎTIER DE LA CELLULE EST ENDOMMAGÉ OU MAL ASSEMBLÉ.**
- **L'EMPLACEMENT DE MONTAGE DE L'UNITÉ DOIT ÊTRE D'AU MOINS 1,5 MÈTRES DE LA PISCINE.**

## 2.4 PLAN AHEAD

The NEXGEN is intended to be installed indoors. It is imperative to have prior knowledge of the facility in which the unit is to be installed. Evaluate space requirements, electrical requirements, and plumbing requirements. Determine what type of tools and hardware will be needed to make the installation as problem free as possible.

## 2.5 ADDITIONAL PARTS REQUIRED FOR INSTALLATION

½ inch polypropylene or polyethylene tubing

¼ inch polypropylene or polyethylene tubing and a ¼ inch valve for tubing connection

PVC tubing in 1.5 inch or PVC pipe in 1.5 inch

PVC 90's, 45's, couplings and saddles or adapters for the return line size encountered

2 inch PVC pipe, 90's, 45's and couplings for the hydrogen vent

Anchors and mounting hardware

Container specified for muriatic acid solutions

## 2.6 POWER SUPPLY ELECTRICAL CONNECTIONS

### WARNING

DO NOT FORGET TO CONNECT THE EARTH TERMINALS AND THE EQUIPMENT BONDING WIRE. THE ELECTRICAL SUPPLY MUST MATCH THE SYSTEM RATED CURRENT. ENSURE THAT POWER IS LINKED TO THE MAIN PUMP POWER SOURCE FOR THE POOL TO ENSURE THAT YOUR **CHLORKING®** NEXGEN SYSTEM NEVER OPERATES WHEN THE POOL PUMPS ARE OFF.

For ease of service, it is recommended that a manual disconnect be installed between the electrical service and the NEXGEN system.

Connect the electrical supply from the pool equipment room to the connections marked 208/240 VAC L1, L2 and ground. Ensure that the electrical service is protected by a circuit interrupter and is rated for the model NEXGEN that is installed.

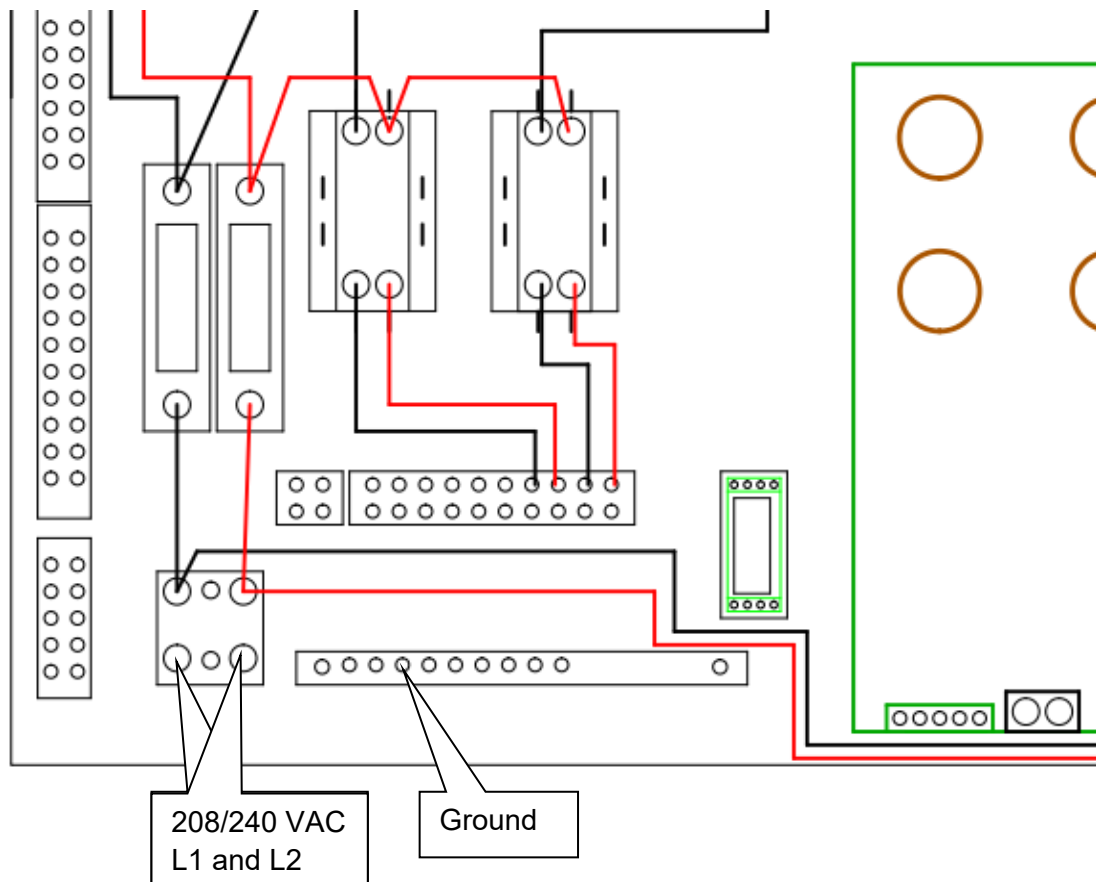

Connect the blue control cord to a chemical feed controller or for manual operation, into a 120V electrical outlet protected by a ground fault circuit interrupter.

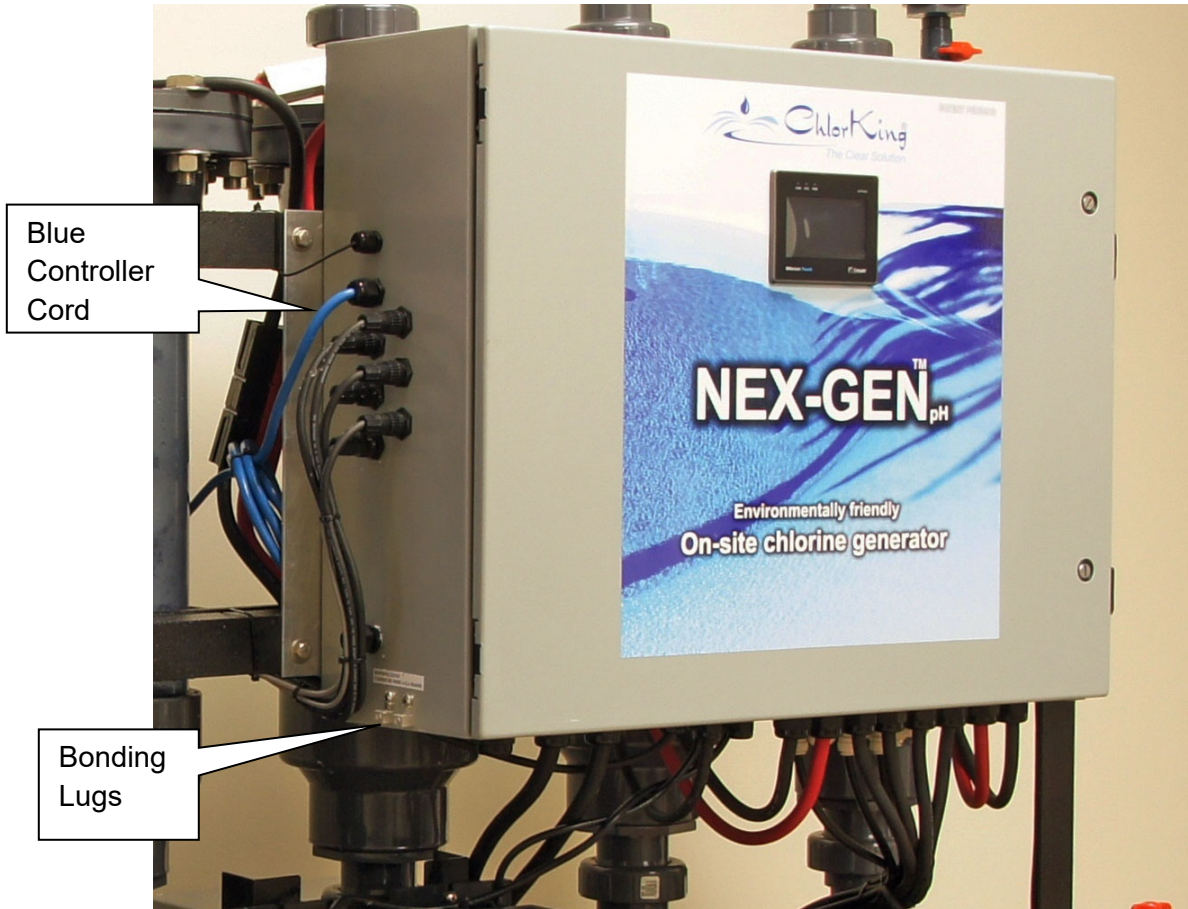

## 2.7 BONDING

Connect a minimum 8awg bonding wire to the bonding lug on the bottom of the electrical enclosure.

## 2.8 PLUMBING CONNECTIONS

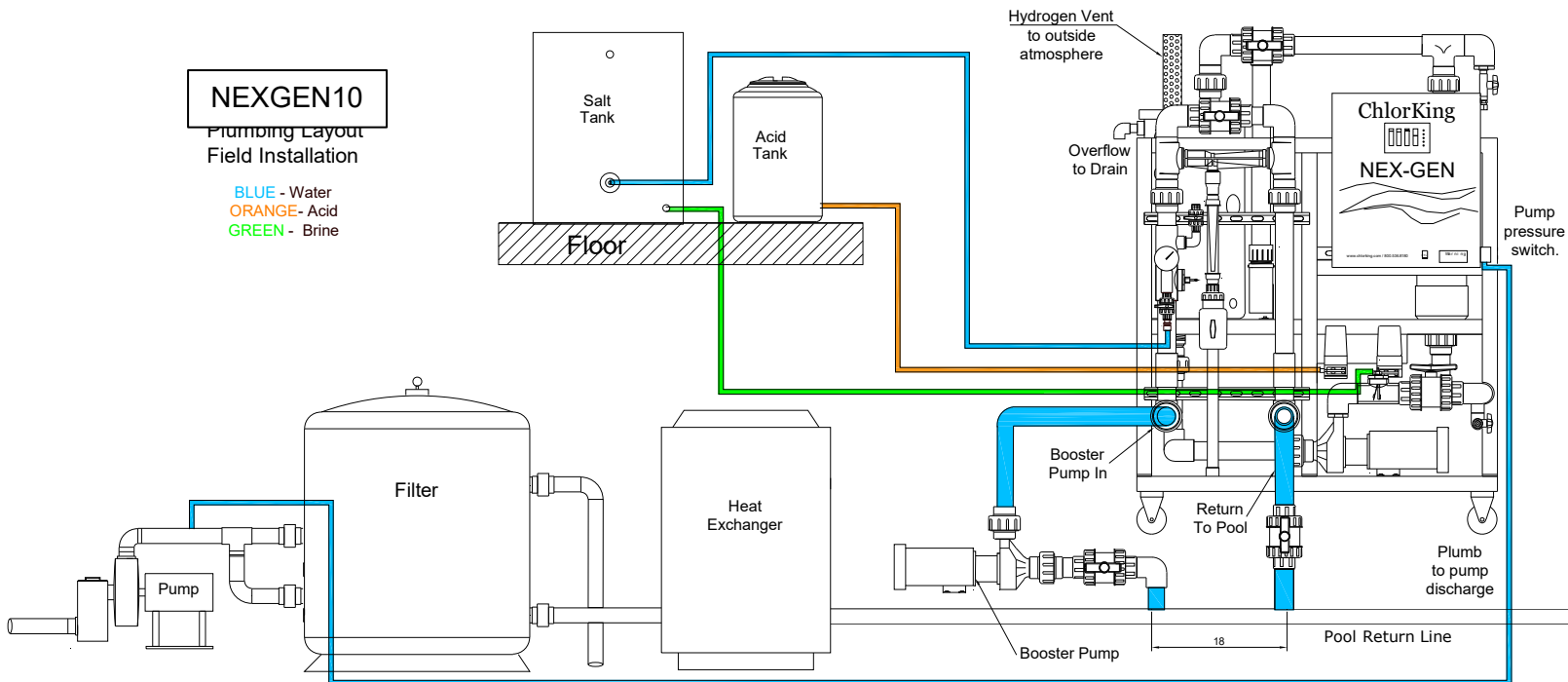

### PLUMBING THE CHEMICAL METERING VENTURI

It is important that the Chemical Metering Venturi is plumbed correctly, or the system will not function properly, and the warranty will be void.

The chemical metering venturi injector requires a pressure differential across the venturi to achieve the rated chemical flow. A booster pump is needed to ensure the required pressure differential is achieved. The NEXGEN will provide 100% of the rated output with a maximum of 25 PSI at the venturi outlet. Install the booster pump in the supply line to the venturi. Consult table below for booster pump sizing.

The booster pump is powered by the NEXGEN and must be installed within 10 feet of the NEXGEN skid to ensure the electrical connection will reach the pump. The pump wiring is located on the bottom side of the enclosure. Wire the booster pump to the NEXGEN with the cable provided and to the pump according to the instructions on the pump for 208/240 VAC connections. The NEXGEN ships with a 12amp breaker for a 1HP pump. Larger pumps will require changing the breaker. Contact ChlorKing for breaker sizing.

Plumb the inlet of the venturi to the booster pump which is connected to the return line of the pool after all other pool components such as heaters etc. Use at least 1.5 inch PVC pipe for this connection. It is recommended that a valve be installed at this connection so that the system can be isolated from the pool.

Plumb the outlet of the venturi to the return line of the pool 18 inches after the inlet plumbing connection. Use at least 1.5 inch PVC pipe for this connection. It is recommended that a valve be installed at this connection so that the system can be isolated from the pool.

Size Booster Pump based on return line pressure	
Return Line Pressure	Pump Horsepower
5 PSI	½ HP
7 PSI	1 HP
12 PSI	2 HP
30 PSI	3 HP



### PLUMBING THE PRESSURE SWITCH

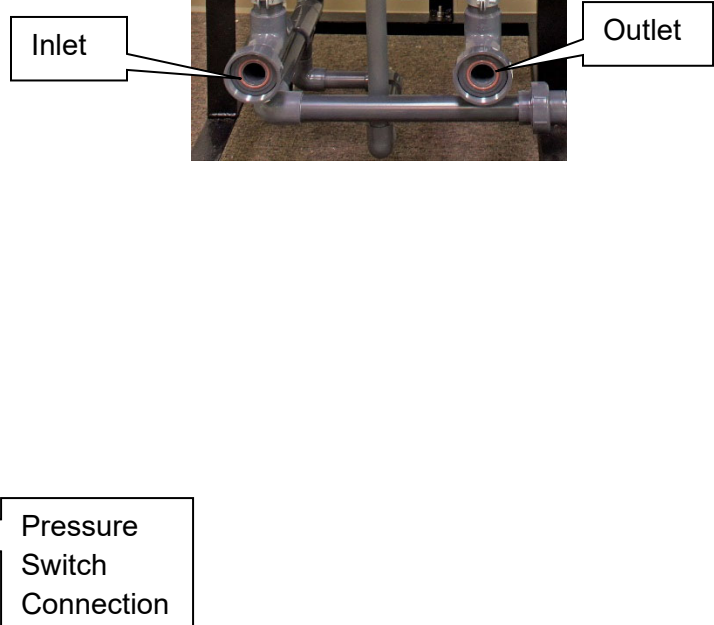
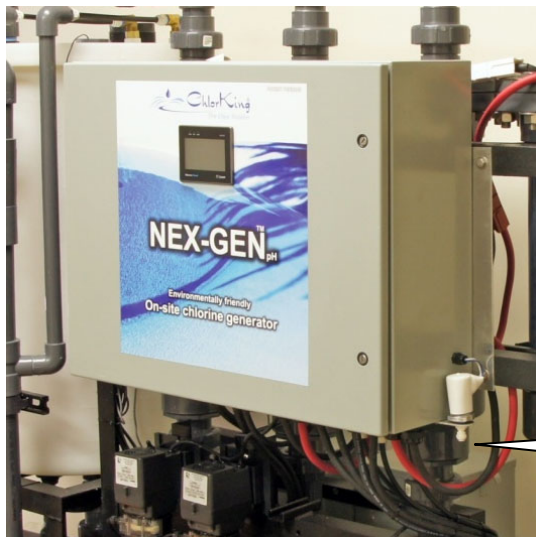

Connect the pressure switch to the return line with ¼ tubing (not supplied) and the ¼ inch valve supplied. The pressure connection should provide a minimum of 5 psi when the pool pump is on, and pressure should be less than 3 psi when the pool pumps are off. Contact ChlorKing for installations that do not meet these specifications.

## 2.9 SATURATED SALT FEEDER INSTALLATION

Place the Saturated Salt Feeder tank in an easy to access location. The tank will need access for adding salt on a continuous basis.



Plumb the peristaltic pump suction line to the salt outlet on the Saturated Salt Feeder with 1/4 tubing supplied with the peristaltic pump. The salt outlet on the Saturated Salt Feeder is a small blue and white valve located at the bottom of the salt feeder. Plumb the Saturated Salt Feeder water supply to the fitting on the chemical metering assembly using 1/2 inch tubing.



## 2.10 PLUMBING THE PRODUCTION TANK OVERFLOW

Install the overflow with the T provided in the installation kit. This T will remain open on top to prevent syphoning in case of tank overflow. The bottom of the T receives a 1" FPT low pressure connection with hose directed to a floor drain, drain tube is not provided.



## 2.11 PREPARING THE pH NEUTRAL SYSTEM

Before use, remove the pH probe from the top of the production tank and remove the cover from the end of the pH probe. Re-install the probe.

Plumb the suction port of the peristaltic pump with the #1 hose to a container (not supplied with the NEXGEN) specified for muriatic acid solutions.

**Note:** Sulfuric acid and dry acid (sodium bisulfate) are not recommended for pH adjustment. Under some conditions the electrolytic cell can be damaged.

### WARNING

Read all cautions and directions provided with the muriatic acid used. Always add acid to water. Use only with adequate ventilation. If strong odor is noticed, STOP, ventilation is inadequate. Leave area immediately. If the work area is not well ventilated, you MUST use a properly fitted and maintained NIOSH approved respirator for acid fumes.

For best results fill the acid tank with a 1 to 1 water / muriatic acid solution.

## 2.12 PLUMBING THE HYDROGEN VENT

### WARNING

**EXPLOSION RISK. FAILURE TO PLUMB THE HYDROGEN VENT TO OUTSIDE ATMOSPHERE MAY RESULT IN DAMAGE TO EQUIPMENT OR PERSONS. ALWAYS VENT THE SYSTEM AWAY FROM SPARK OR FLAME**

Hydrogen vent pipes must be rigid plastic (PVC) and installed in a continuous upward gradient of at least 1/8 inch per foot. The pipe must be vented to outside atmosphere. Use a minimum of 2 inch pipe for the vent. The vent pipe should not be longer than 100 feet. (Consult ChlorKing if longer runs are required). Keep the opening clear and protected from water or debris with the use of a hood or bend.





## SECTION 3 OPERATION

### 3.1 START-UP PROCEDURES AND CHECKS

Check that all components are mounted securely. Check that all plumbing is secure and tight. Check that all plumbing and electrical connections are connected in the proper place.

Ensure that all system isolation valves installed during installation are open.

Fill the Saturated Salt Feeder with pure rock or pellet salt. **Do Not Use Granular Salt.** Open both Saturated Salt Feeder valves.

Fill the muriatic acid container with a 50% water to 50% muriatic acid solution.

Turn on any breakers or disconnect boxes used for circuit protection.

Ensure the blue cord is connected to a chemical feed controller and the controller is calling for feed, or that the blue cord is plugged into a live outlet.

The NEX-GEN will go through a series of startup steps and automatically start generating chlorine.

If the NEX-GEN does not start automatically, see the Troubleshooting Guide.

### 3.2 ADJUSTING CHLORINE OUTPUT

Adjust the flow through the flow meter for the following production rates:

- .6 GPM = 12 pounds of chlorine production per day
- .44 GPM = 9.8 pounds of chlorine production per day
- .36 GPM = 10.6 pounds of chlorine production per day
- .16 GPM = 9.2 Pounds of chlorine production per day

#### NOTE

The maximum production rate of 12.0 pounds is achieved at 7000 ppm salt concentration and .6 GPM.

Adjustments in excess of .6 gallons per minute will not produce more chlorine. Adjustments in excess of .6 gallons per minute will only consume excess salt.

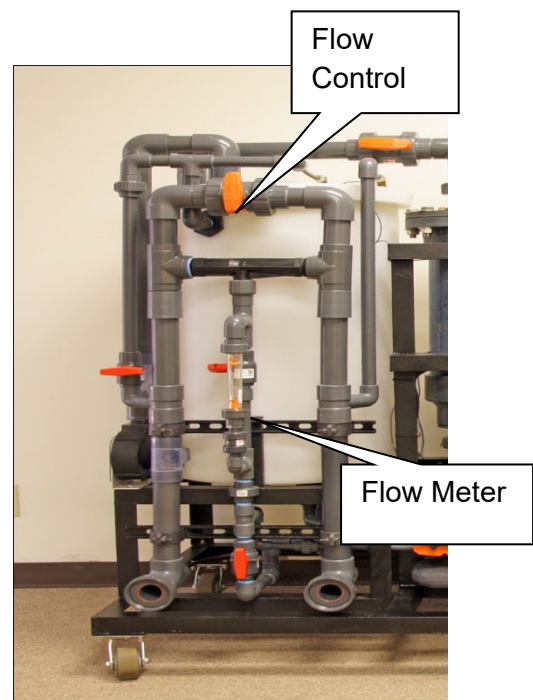

### 3.3 TOUCH SCREEN ICON EXPLANATIONS



This icon is displayed if the system is turned off.



This icon is displayed if the system is waiting for a signal from an external controller.



This icon is displayed if cell cleaning mode has been selected. This icon will be displayed until the cell cleaning process is complete.



This icon indicates a failure during the acid wash sequence for cell maintenance.



Press this icon to clear the fault described above.



This icon indicates that acid is being pumped during the cell cleaning cycle.



Faults are accompanied by a beeping sound. If this icon is visible, pressing it will stop the beeping sound.

### 3.4 USING THE TOUCHSCREEN

#### Home Screen

Below is the HOME screen that will be displayed any time the NEXGEN is operating normally.

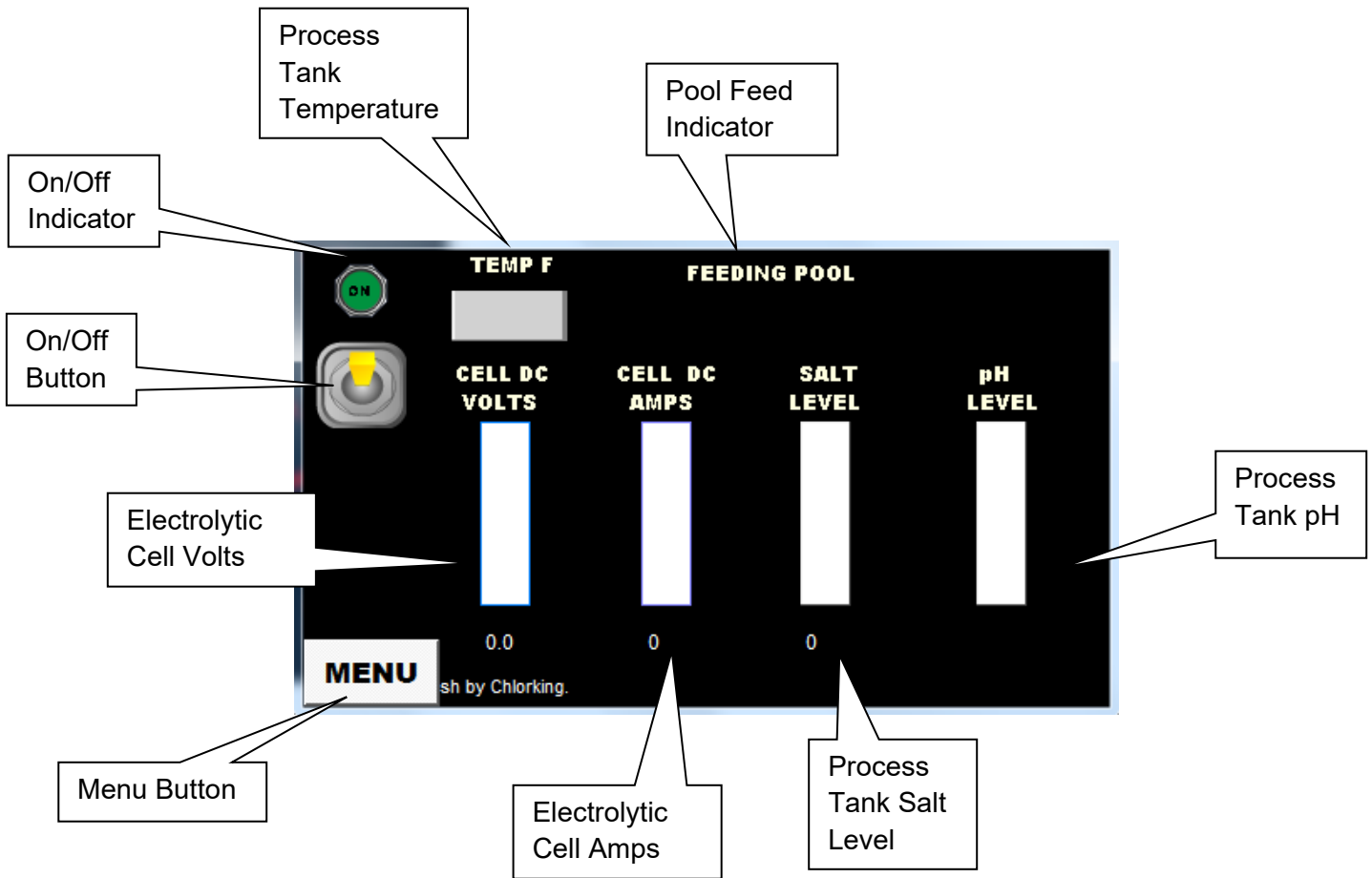

## Turning the NEXGEN On or Off

To turn the system on or off, press and hold the ON/OFF button until the desired ON/OFF indicator is displayed. The NEXGEN may take several minutes to completely turn on or off.

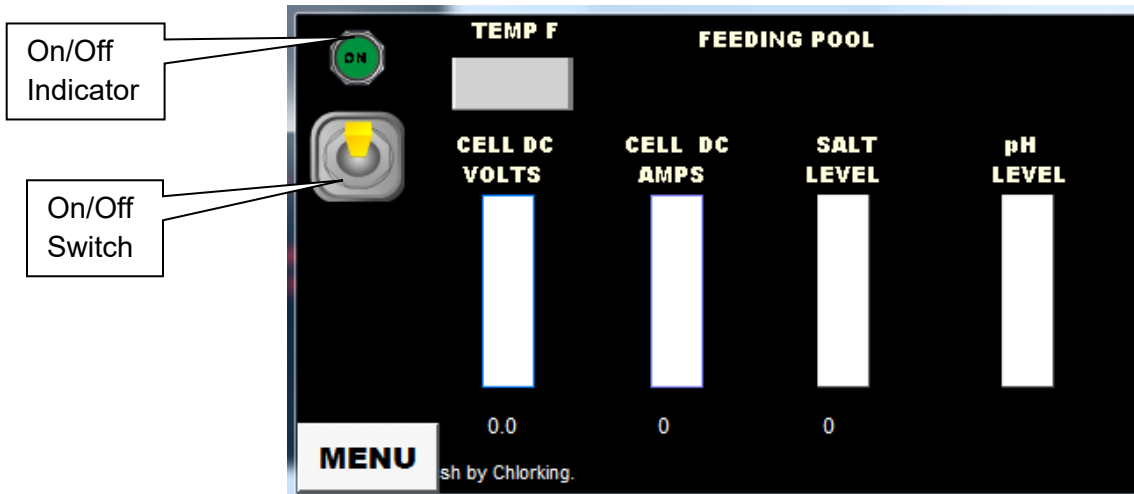

## The Menu

Press the MENU button to access the HOME, SERVICE and EVENTS buttons.

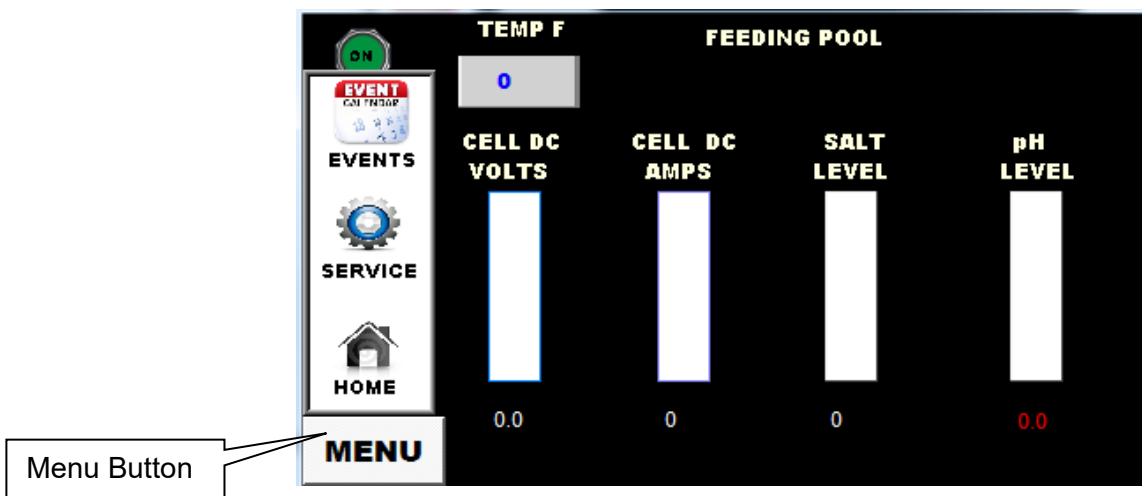

## The Service Screen

Press MENU then SERVICE to access the SERVICE screen. The service screen has the option to view the current state of the system OUTPUTS, the current state of the system INPUTS, to manually TEST system outputs, to view or set system SETPOINTS, and to view recorded data.

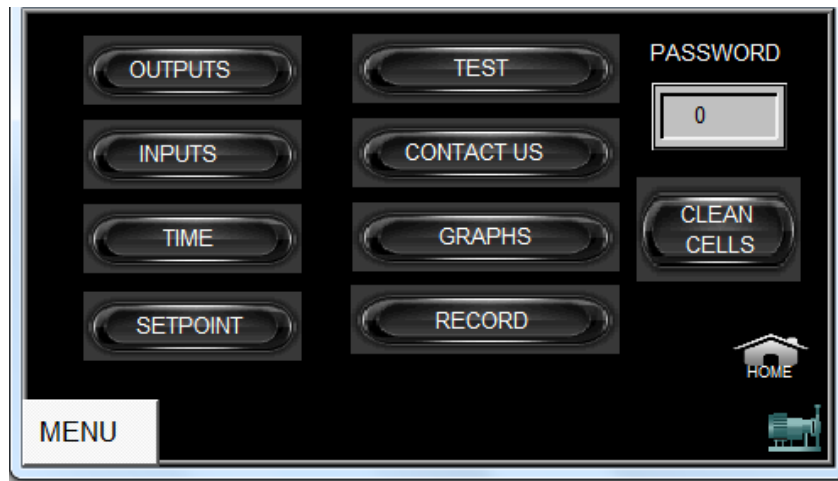

## View System Digital Inputs

Press MENU then SERVICE then INPUTS to display the current state of all digital inputs. An active input is indicated by the GREEN dot next to the input name. A check mark indicates the parameter is OK. A RED dot indicates an inactive input. The number or letter inside of the dot indicates the actual input number on the PLC.

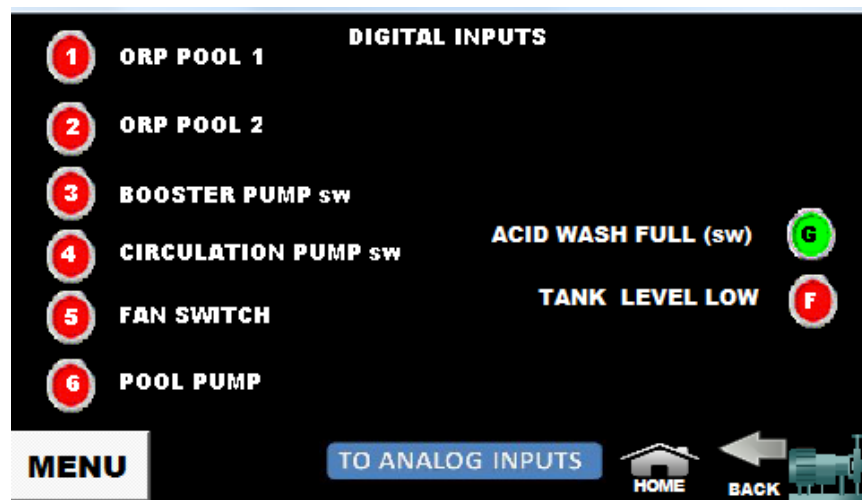

## View System Analog Inputs

Press MENU then SERVICE then INPUTS then ANALOG INPUTS to display the current value of all analog inputs. The letters inside of the dot indicates the actual input number on the PLC.

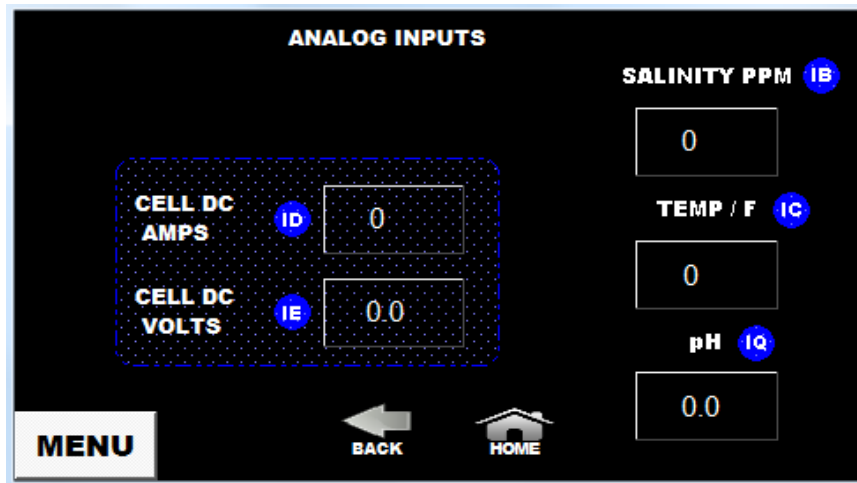

## View System Outputs

Press MENU then SERVICE then OUTPUTS to display the current state of all outputs. An active output is indicated by an icon next to the output name. The number next to the output indicates the actual output number on the PLC.

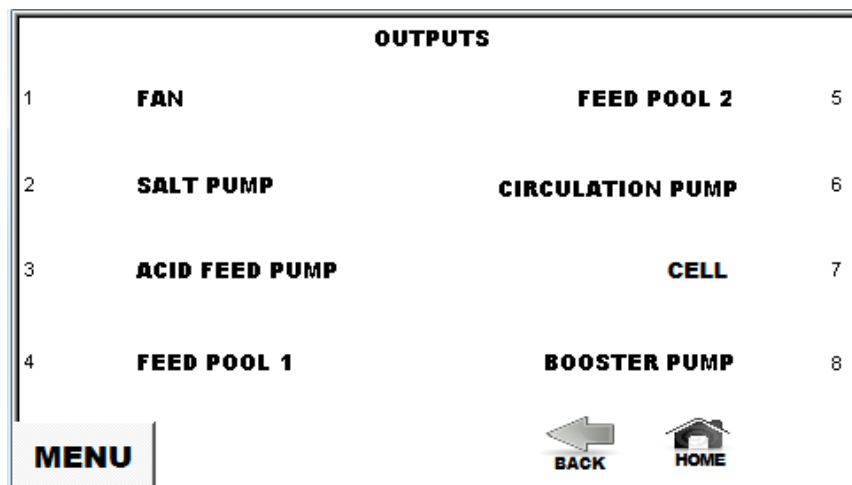

## System Tests

**Note: Selecting the TEST screen will turn the NEXGEN system off.**

Press MENU then SERVICE then TEST to view the test screen. Press NEXT for the second TEST screen. The following components can be manually operated for testing from these screens.

- Booster Pump and Booster Pump Flow Switch
- Circulation Pump and Circulation Pump Flow Switch
- Salt Pump and Salt Sensor Reaction
- pH Pump and pH Reaction (Press for 2 seconds)
- Acid Wash Pump (Press for 2 seconds)
- Hydrogen Vent Blower and Flow Switch
- Feed Valve 1
- Feed Valve 2 (ORP 2 must be active for this test)

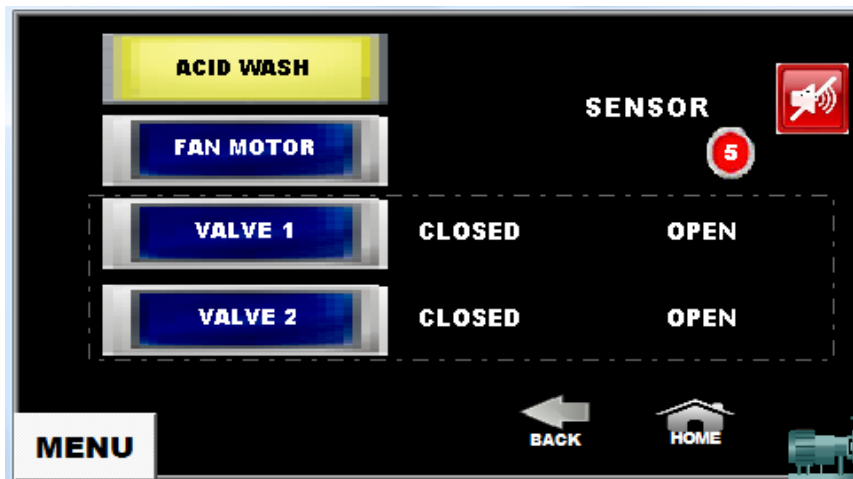
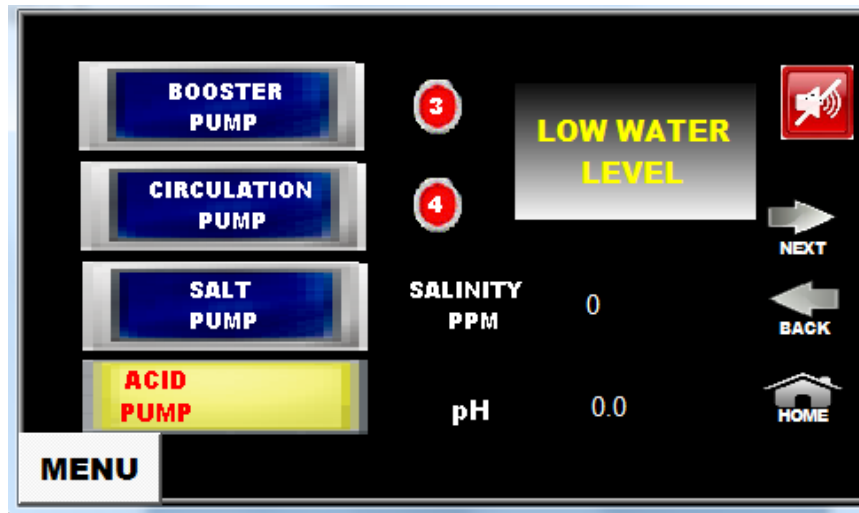

## Viewing or Changing Set-points

Press MENU then SERVICE then SETPOINT to access the set-point screen. From this screen the SALT SETPOINT, PH SETPOINT, ACID FEED TIME, and MINIMUM SALINITY can be adjusted. The factory default is 7000 for salt, 7.4 for pH, and 60 seconds for feed time.

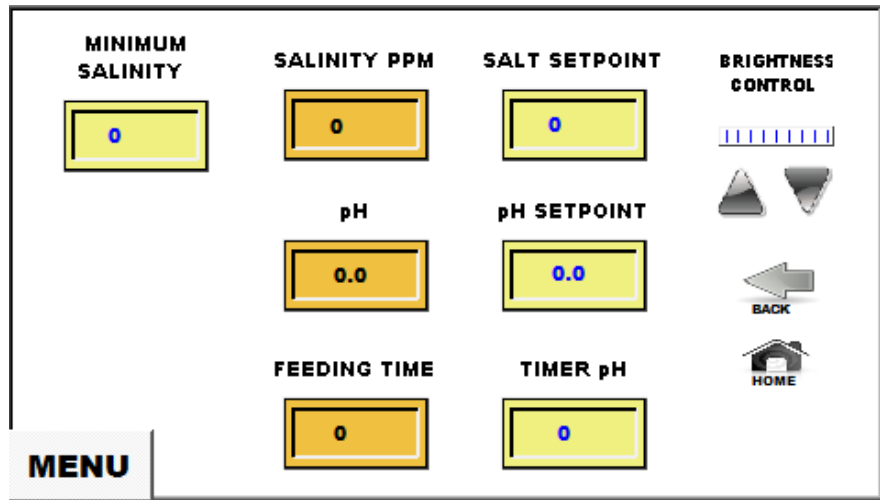

## Adjusting pH Feed Times

Press MENU then SERVICE then SETPOINT to access the set-point screen. From this screen the PH FEED TIME can be adjusted. The factory default is 60 seconds.

## Accessing the Recorded Event Log

Press MENU then SERVICE then RECORD to access the event log screen. The event log will store every system event that has occurred by date and order.

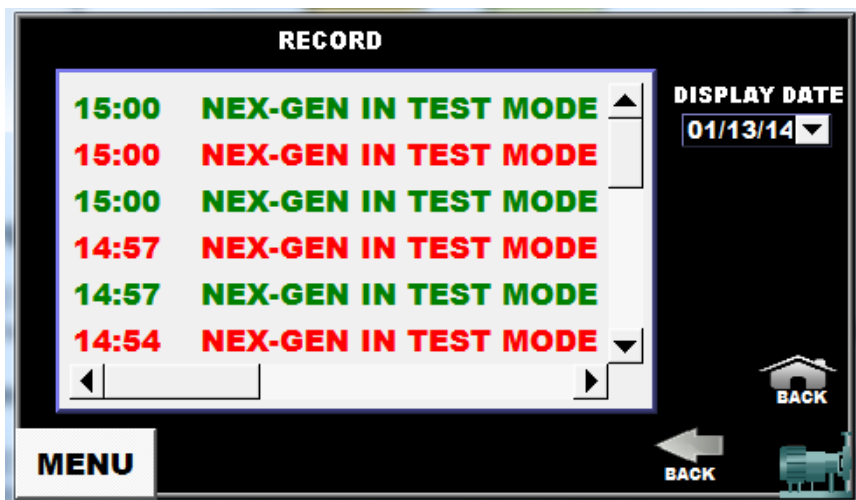



## Accessing Graphs

Press MENU then SERVICE then GRAPHS to access the graphs screen. From this screen process temperature, process pH, and low pH can be seen over history.

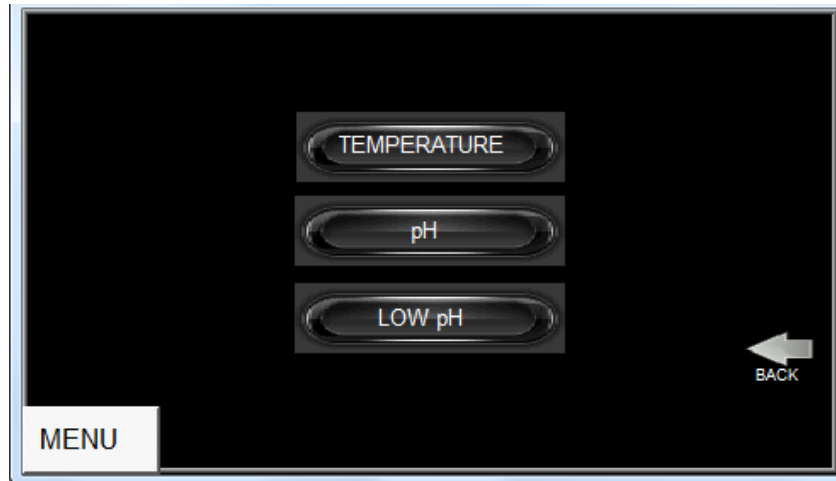

## Accessing the Current Event Log

Press MENU then EVENTS to access the current event log. This screen lists current events or faults. This screen will also activate automatically whenever a fault occurs. A current fault is displayed in black. Pressing the red ACKNOWLEDGE ALL EVENTS button and then the RESET ALARM button will reset all alarms.

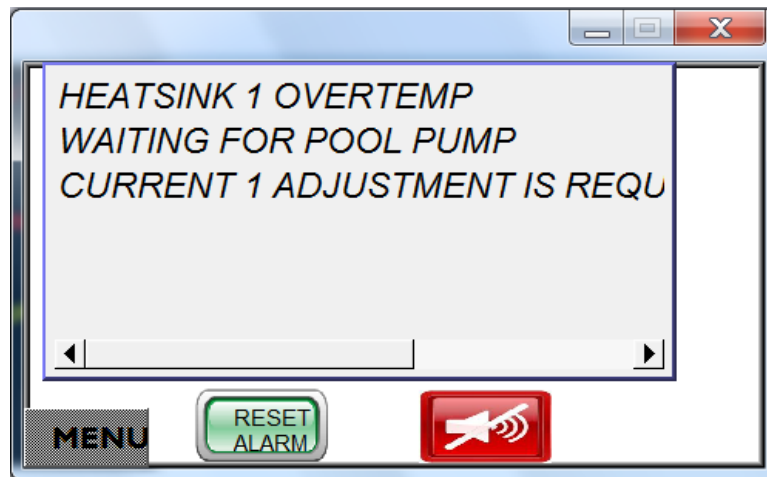

## SECTION 4 MAINTENANCE

### 4.1 ROUTINE MAINTENANCE

#### Daily

Confirm system operation with a visual inspection. Check the salt concentration on the display. Check the amps as displayed on the gauge. Check the flow through the flow meter.

#### Weekly

Clean the electrode stacks each week or as needed based on the presence of calcium buildup.

Check the salt in Saturated Salt Feeder and fill as needed.

#### Monthly

Check the system filter (if installed), production tank filter (if installed), and dilution fan screen and clean as necessary.

### 4.2 CELL CLEANING PROCEDURE

Press MENU then SERVICE then CLEAN CELLS to access step by step instructions for cleaning the cells.

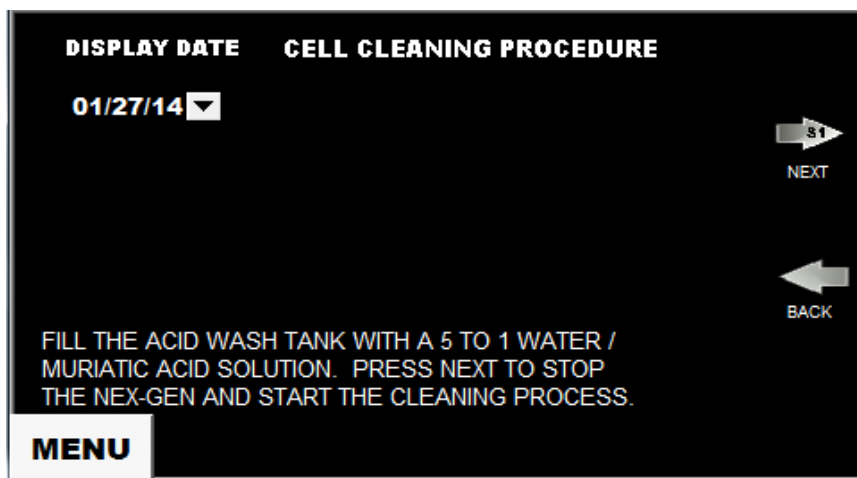

**Note:** Sulfuric acid and dry acid (sodium bisulfate) are not recommended for cell cleaning. Under some conditions the electrolytic cell can be damaged.

## WARNING

Read all cautions and directions provided with the muriatic acid used. Always add acid to water. Use only with adequate ventilation. If strong odor is noticed, STOP, ventilation is inadequate. Leave area immediately. If the work area is not well ventilated you MUST use a properly fitted and maintained NIOSH approved respirator for acid fumes.

Fill the acid wash tank with a 5 to 1 water / muriatic acid solution.

Press NEXT to continue.

All valves on the NEXGEN are clearly marked with valve tags. The valves to be adjusted in each step will be flashing on the screen.

**STEP 1** – Close the Tank Fill Valve marked 3. Close the Product Flow Adjustment Valve marked 4. This will allow the tank to drain for cleaning.

Press NEXT to continue.

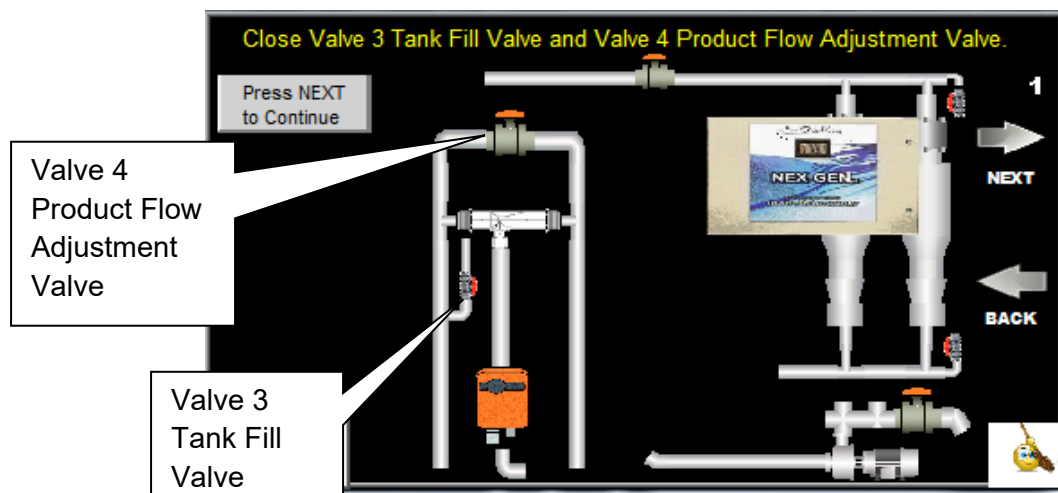

**STEP 2** – During this step the booster pump will start and the product tank will empty. When the tank is empty the GREEN Low Level Sw will turn RED.

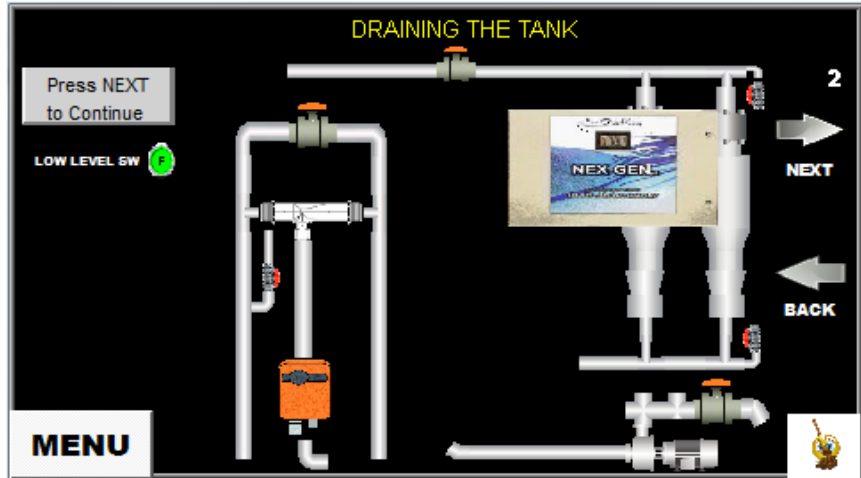

When the tank has emptied the TANK EMPTY will be displayed.

Press NEXT to continue.

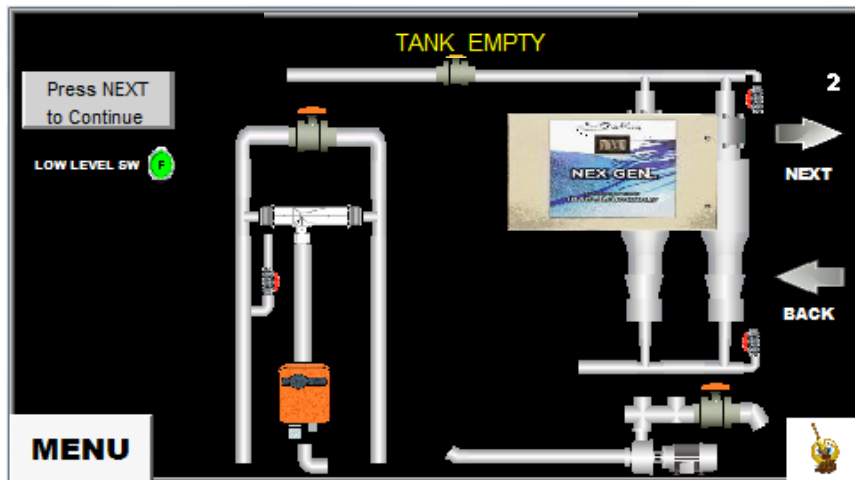

**STEP 3** – Open Tank Fill Valve marked 3.

Press NEXT to continue.

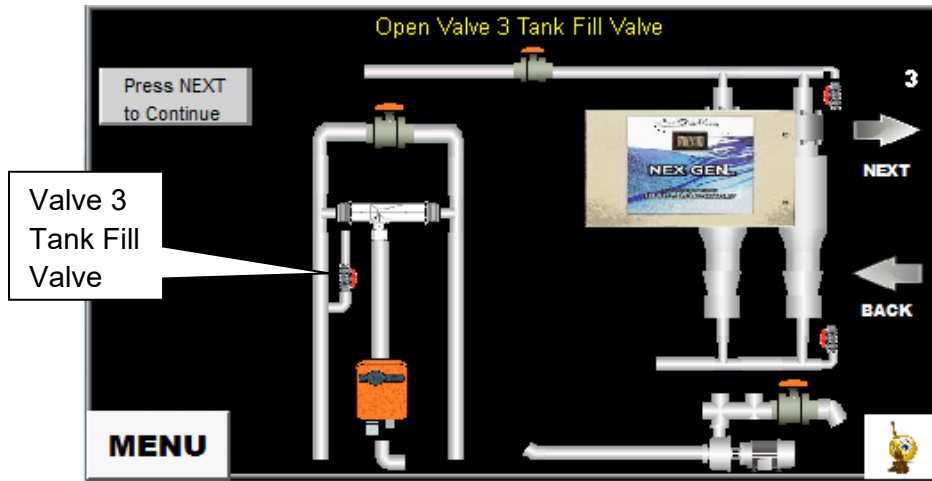

**STEP 4** – This step will fill the tank for flushing. When the tank is full the RED Level In Tank (Cond) will turn GREEN and the display automatically changes to the screen on the next page.

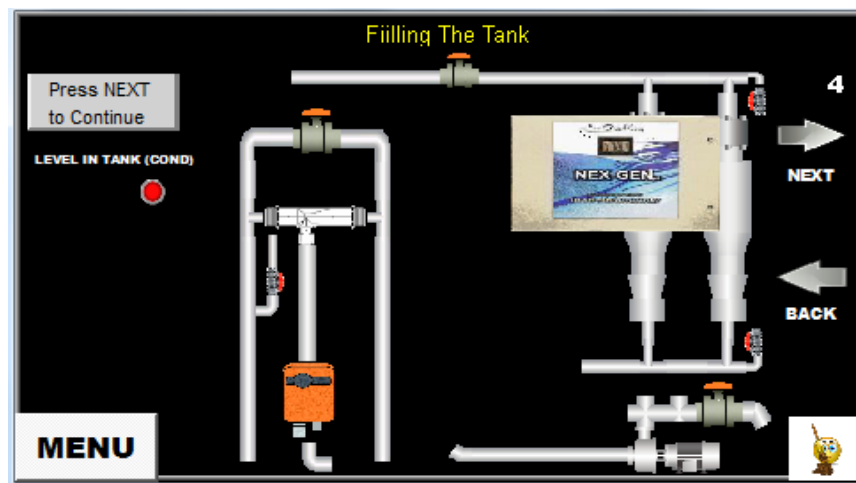

Close Valve 3 Tank Fill Valve

Press NEXT to continue.

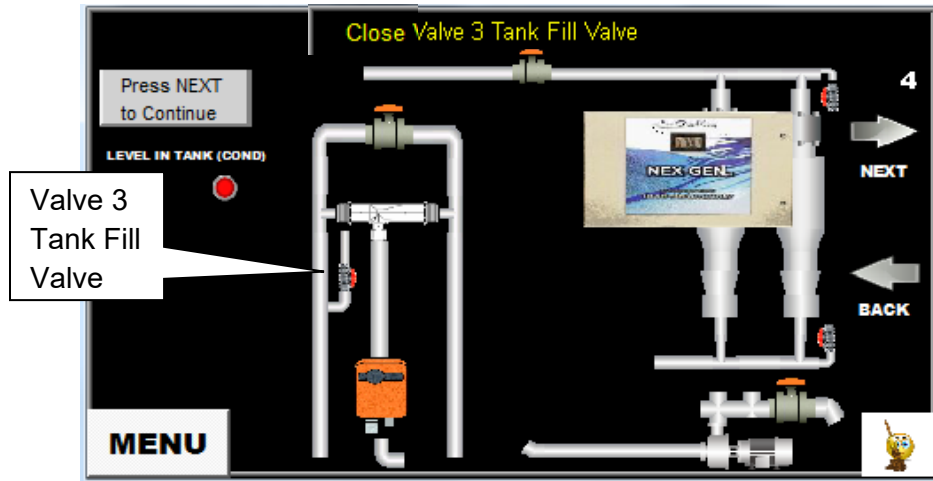

**STEP 5** – The system will flush and drain the tank. When flushing and draining is complete, the Low Level Sw will turn from GREEN to RED and the display will prompt you to Press NEXT to continue.

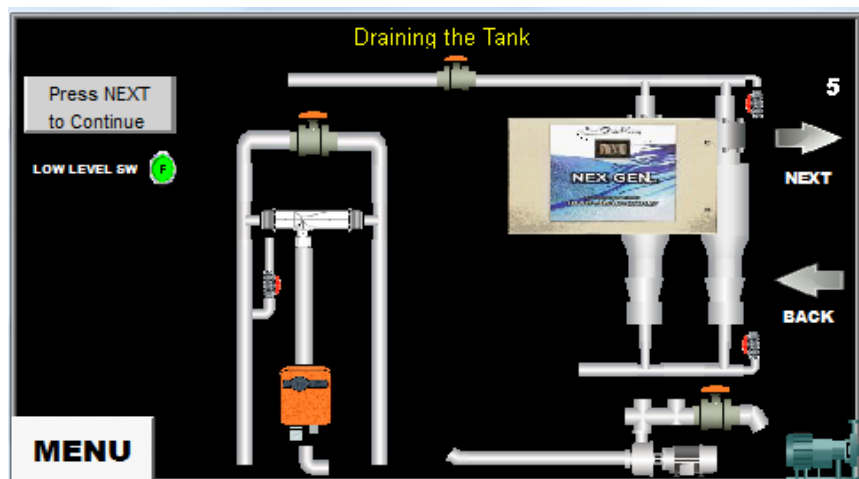

**STEP 6** – Close the Cell Output Valve marked 8 and the Pump Isolation Valve marked 7.

Press NEXT to continue.

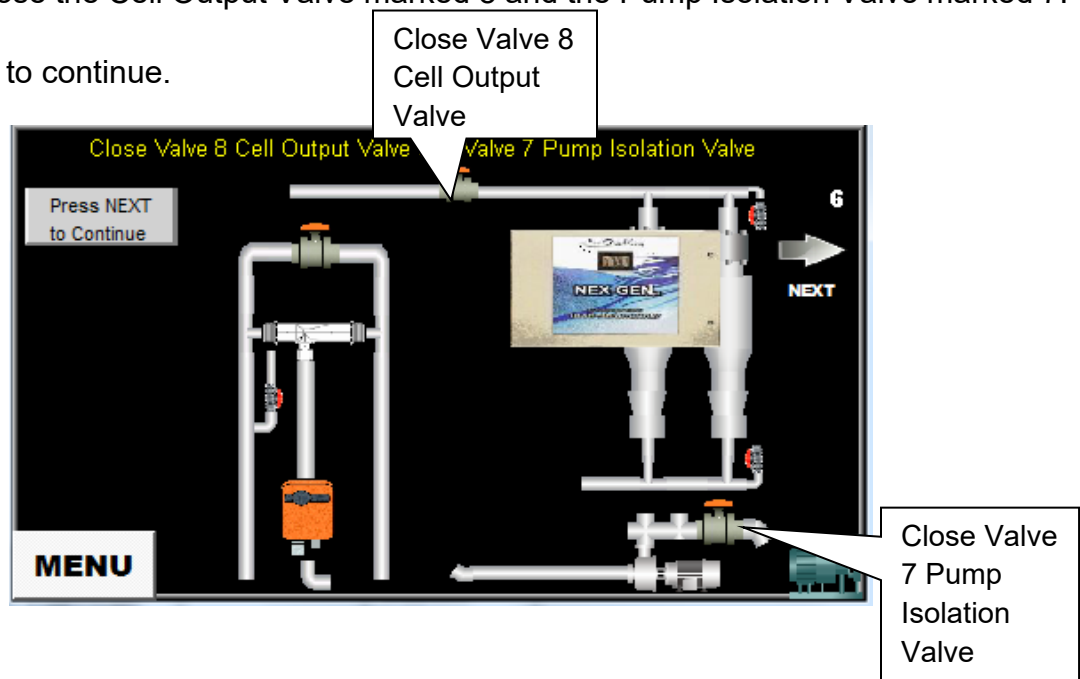

**STEP 7** – Connect Acid Wash Inlet Coupling to the Acid Wash Inlet Valve colored White. Connect Acid Wash Outlet Coupling to the Acid Wash Outlet Valve colored Gray.

Press NEXT to continue.

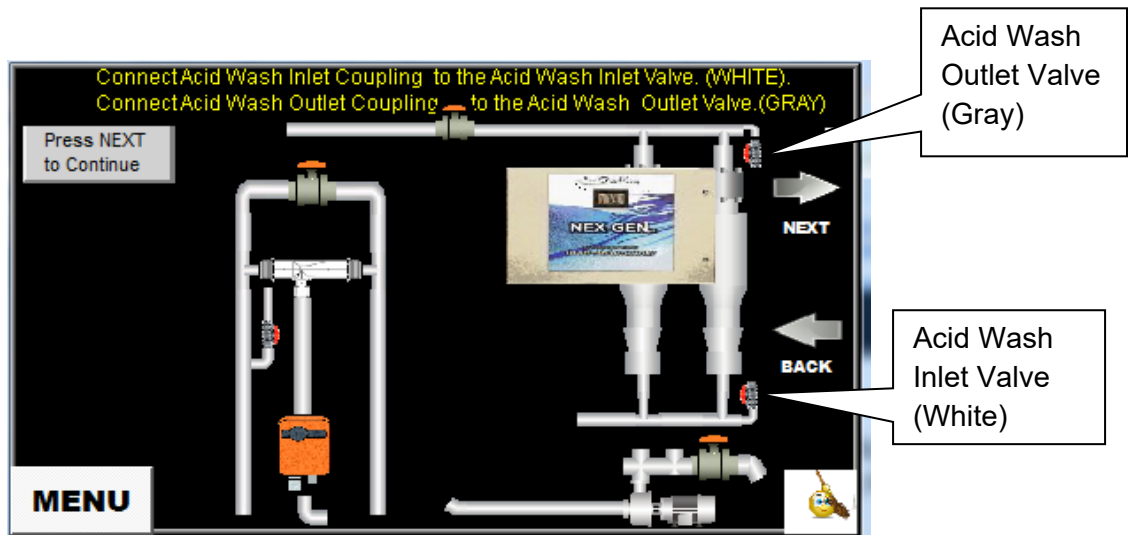

**STEP 8** – Open the Acid Wash Inlet and Outlet Valves.

Press NEXT to continue.

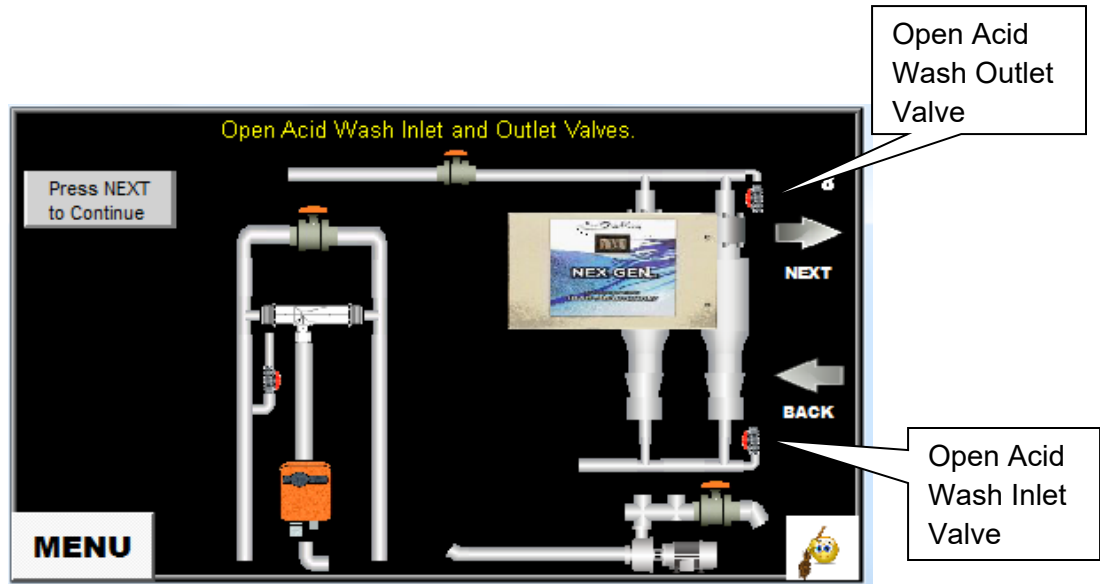

**STEP 9** – Open both White Acid Wash Valves on the Acid Wash assembly.

Press NEXT to continue.

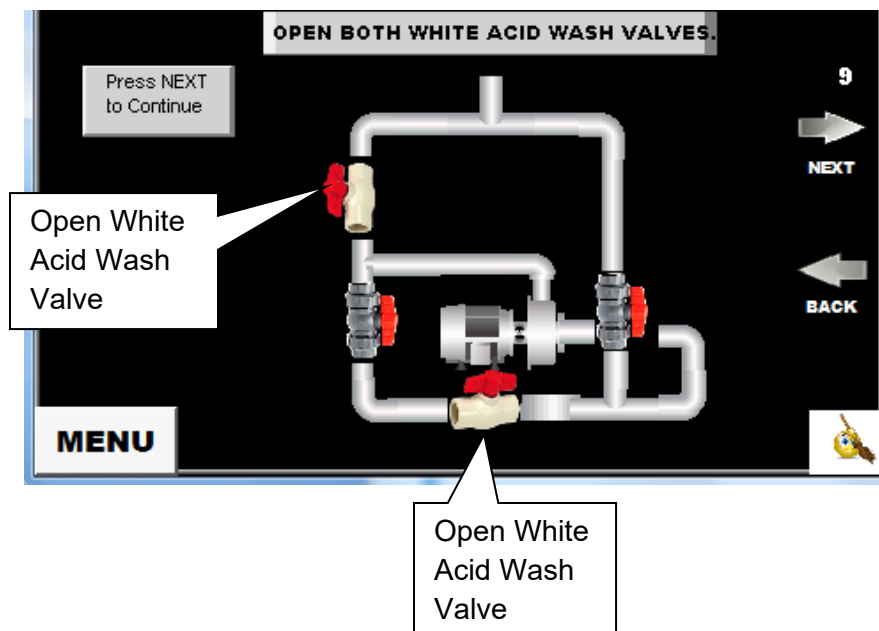



**STEP 10** – Close both Gray Acid Wash Valves on the Acid Wash assembly.

Press NEXT to continue.

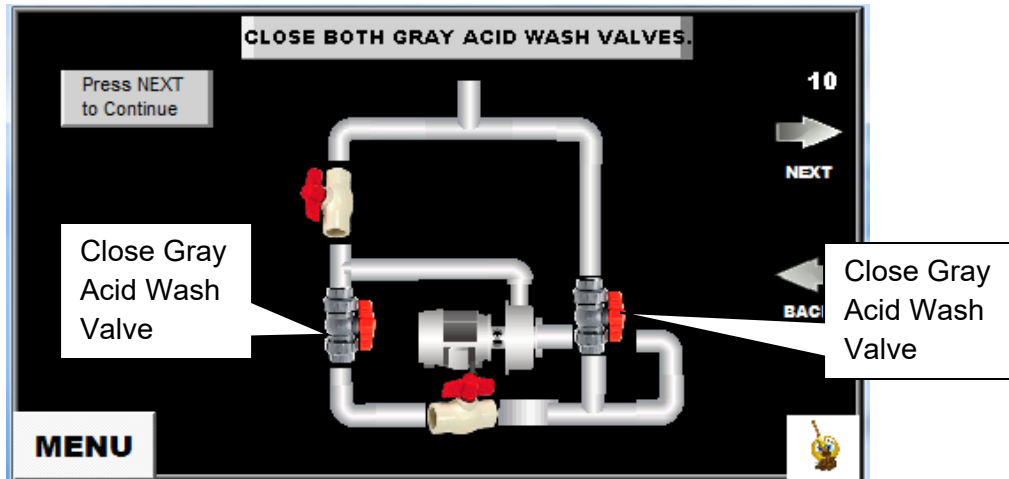

**STEP 11** – Plug the Acid Wash Assembly into the Special Power Connector and turn on the Acid Wash Pump on the skid.

Press NEXT to continue.



**STEP 12** – Press the blue “Press to Acid Wash” button. The Acid Wash assembly will begin to fill the NEXGEN with muriatic acid and circulate the acid through the cells for as long as 30 minutes. If the cells are clean before the 30 minute time interval has expired, press the blue Acid Wash button to stop the process.

Press NEXT to continue.

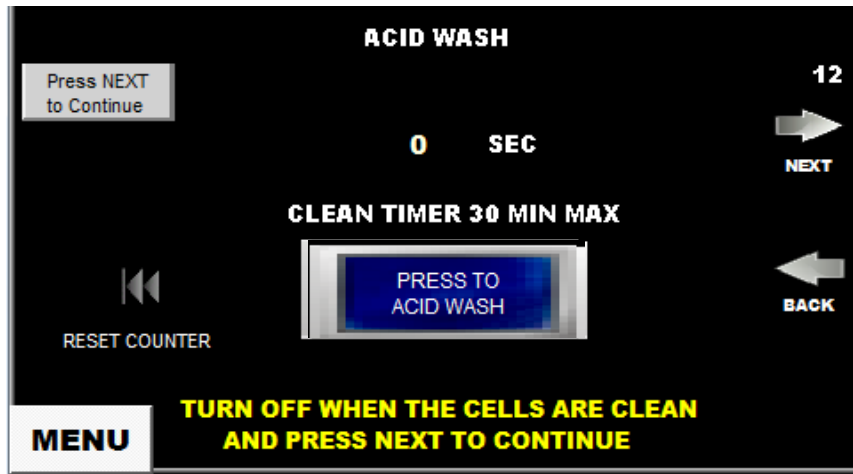

**STEP 14** – Open both Gray Acid Wash Valves on the Acid Wash assembly.

Press NEXT to continue.

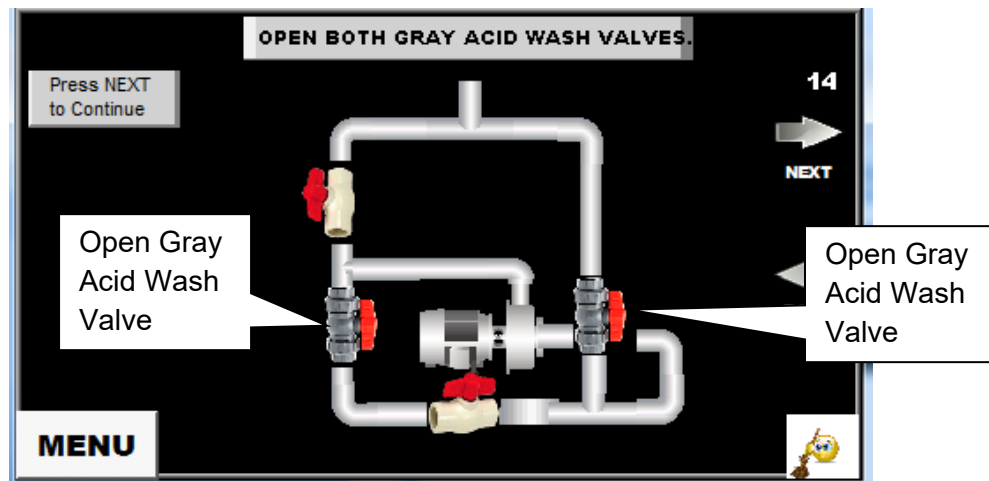

**STEP 15** – Close both White Acid Wash Valves on the Acid Wash assembly.

Press NEXT to continue.

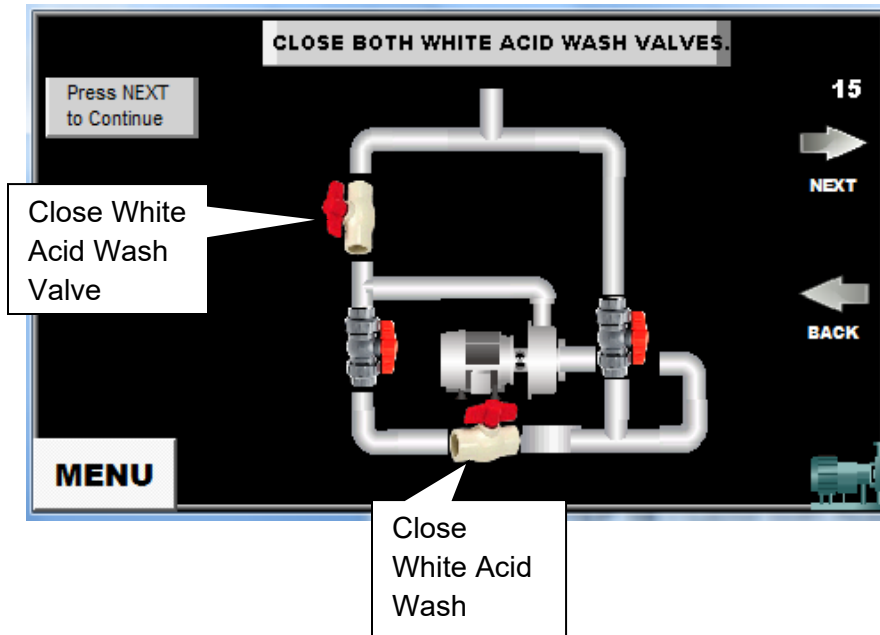

**STEP 16** – Press the blue “Press to Drain” button. The Acid Wash assembly will begin to drain the muriatic acid from the NEXGEN. This process allows user adjustable draining for 150 to 250 seconds to complete draining. Adjust the drain time so that the cells drain completely but the pump does not run dry. Drain times will vary with each installation. Once the drain time has been adjusted, it should need adjusting again.

Press NEXT to continue.

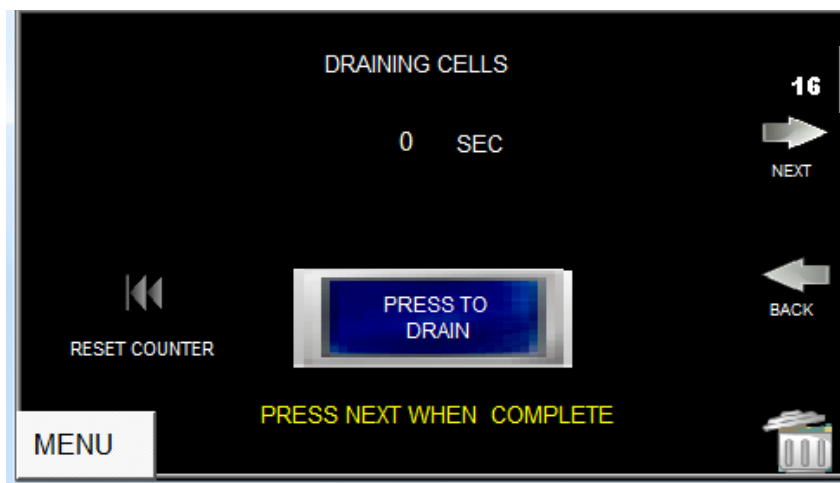

**STEP 17** – Close the Acid Wash Inlet and Outlet Valves.

Press NEXT to continue.

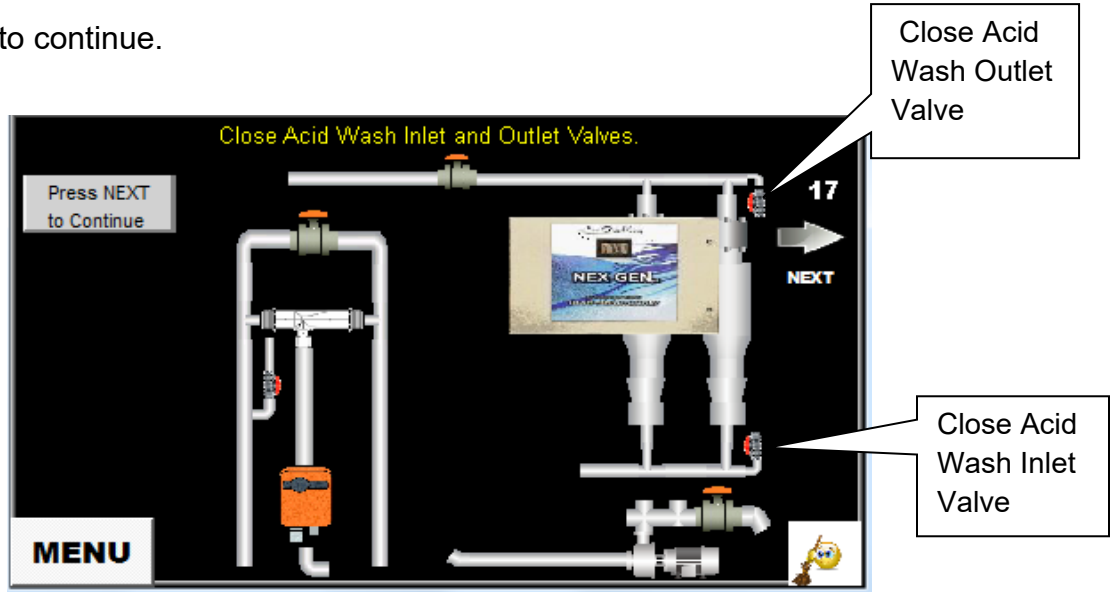

**STEP 18** – Unplug the Acid Wash Assembly from the Special Power Connector and turn off the Acid Wash Pump on the skid.

Press NEXT to continue.

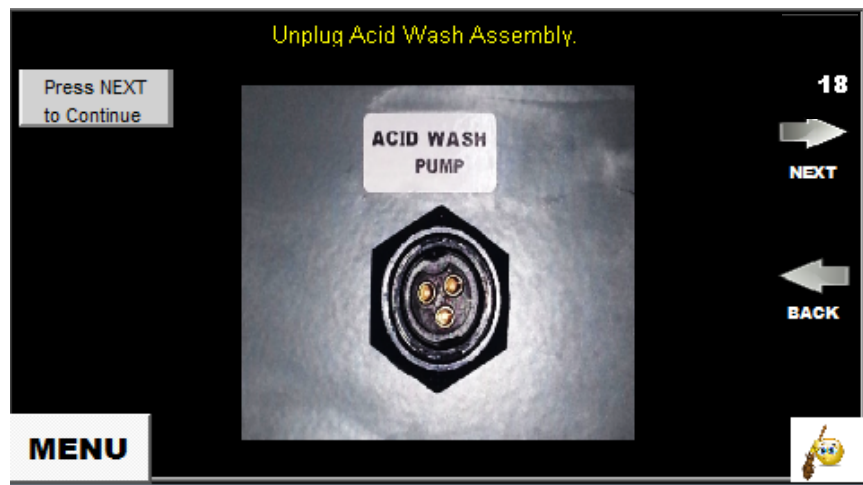

**STEP 19** – Disconnect Acid Wash Coupling Inlet and Outlet from the Acid Wash Inlet and Outlet Valves.

Press NEXT to continue.

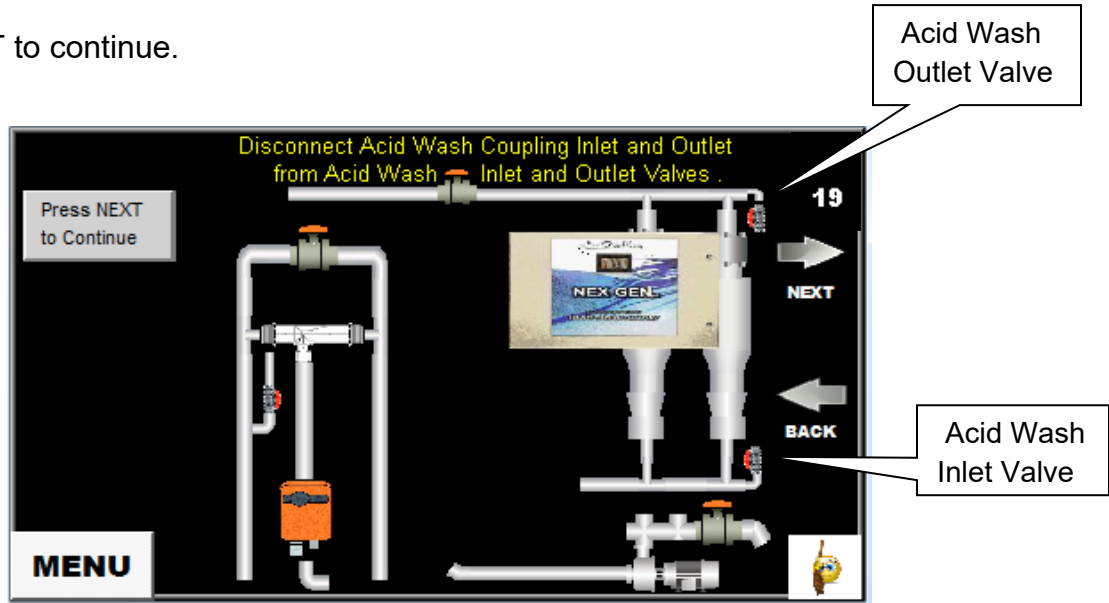

**STEP 20** – Open Cell Output Valve marked 8 and the Pump Isolation Valve marked 7.

Press NEXT to continue.

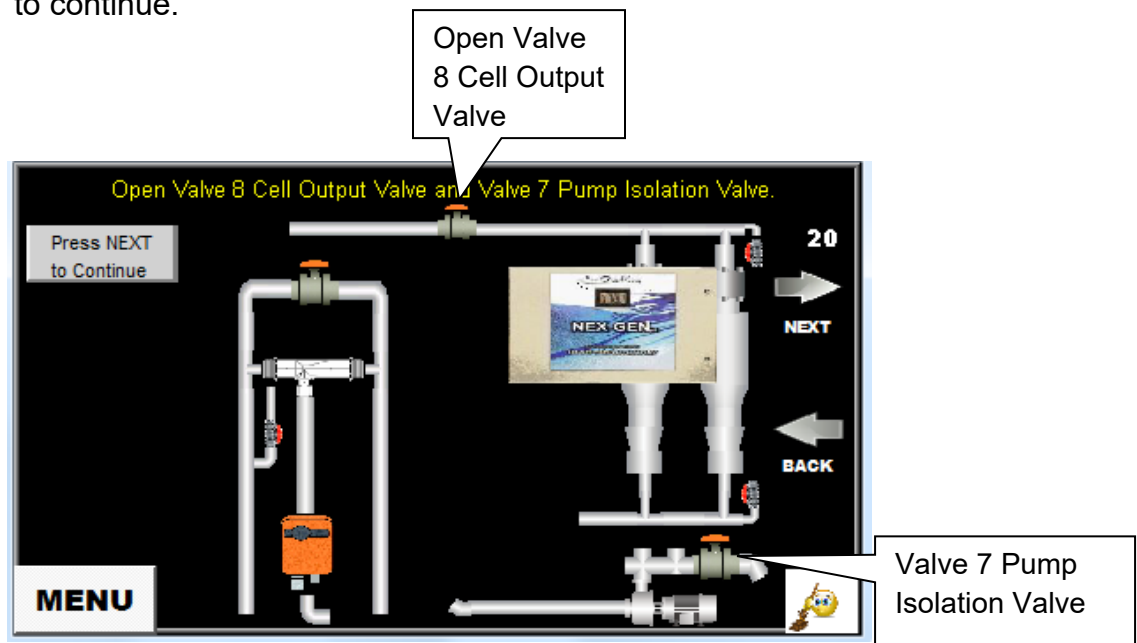

**STEP 21** – This step will empty any remaining acid from the cells. When the process is complete the Press NEXT to continue prompt will allow you to move to the next step.

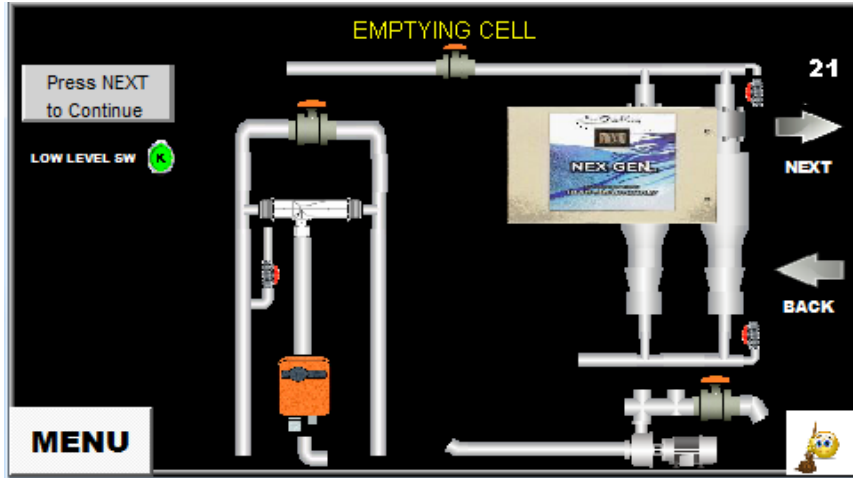

**STEP 22** – Open Valve 3 the Tank Fill Valve.

Press NEXT to continue.

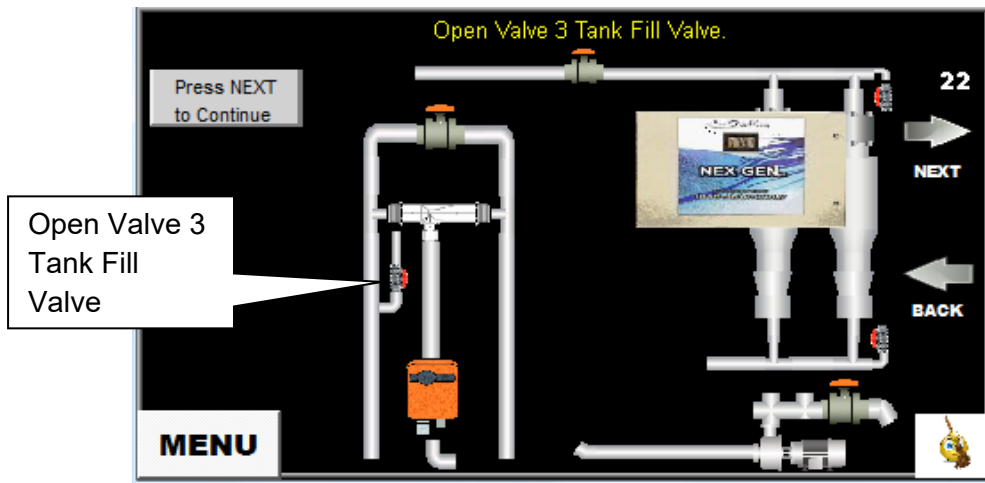

**STEP 23** – This step will fill and flush the system. Once filling and flushing is complete, the current system pH will be displayed and you will be prompted to press NEXT to continue.



**STEP 24** – Adjust the Production Flow Valve marked 4 to the desired flow rate outlined in Section 3.2 on page 16.

Press NEXT to continue.

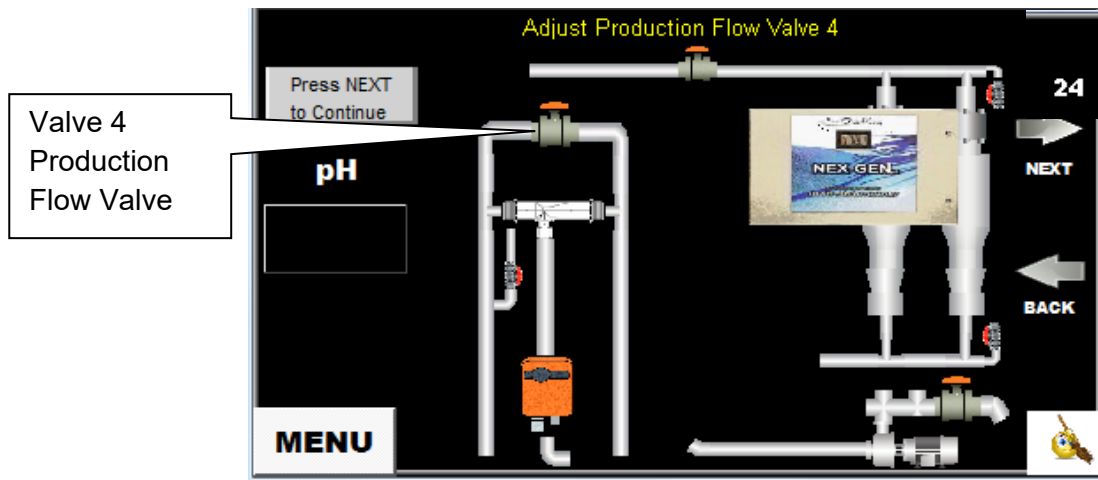

**STEP 25** – Cell cleaning is finished.

Press NEXT to continue.



The home screen will be displayed. The NEXGEN will start automatically. The startup process will include automatic adjustment of the pH and salt concentration in the production tank. Once this process is complete the NEXGEN will resume normal operation.

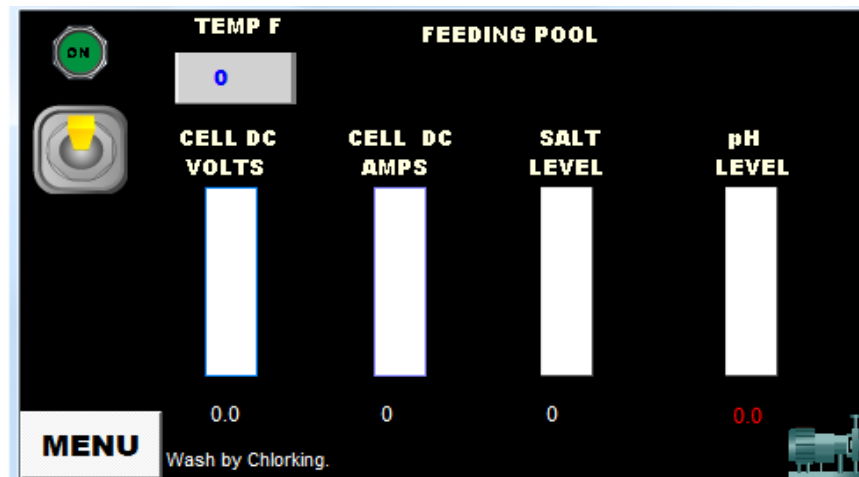



## SECTION 5 WARRANTY INFORMATION

The **ChlorKing®** NEXGEN system carries a limited 3-year warranty

1. 3-year warranty on assembly of the system.
  2. 1 year on all electrical items, cell tubes, and production tanks.
  3. 2 years pro-rated monthly, on titanium electrodes. (Year 1 is warranted fully, thereafter pro-rated warranty applies, applicable over the full 2-year period. Applicable on electrode stacks where full price has been paid.)
- **ChlorKing®** advises that titanium electrodes will have to be replaced approximately every 15,000 hours of operating time.
  - **ChlorKing®** warranties will not be honored should it be shown that the operating and maintenance procedures have not been followed, particularly with regard to the cleaning frequency program.
  - **ChlorKing®** warranties of the titanium electrodes will not be honored if the system is operated in water temperatures lower than 59 degrees F.
  - During the warranty period the customer shall return the defective component, freight prepaid, accompanied by the original invoice or proof of purchase, and **ChlorKing®** shall at its sole discretion elect to repair or replace the defective component and return it to the customer, freight pre-paid.

**ChlorKing®** accepts no responsibility other than to repair or replace a defective component, and this warranty specifically excludes product failure due to accidental damage, abuse, misuse, and negligence, damage due to non-compliance of the operating manual or unauthorized alterations or modifications to the system. **ChlorKing®** accepts no responsibility and is not liable for any extended warranties or variations to this warranty offered by re-sellers of **ChlorKing®** systems.